



# Razorweld®

## OPERATING MANUAL

**KUMJRRW145**

**KUMJRRW180**

**KUMJRRW210**



**3 YEARS Warranty**  
(Power Source)

**Please read and understand this instruction manual carefully before the installation and operation of this equipment.**

## **Thank you for your purchase of your RAZORWELD Welding Machine.**

We are proud of our range of welding equipment that has a proven track record of innovation, performance and reliability. Our product range represents the latest developments in Inverter technology put together by our professional team of highly skilled engineers. The expertise gained from our long involvement with inverter technology has proven to be invaluable towards the evolution and future development of our equipment range. This experience gives us the inside knowledge on what the arc characteristics, performance and interface between man and machine should be. Within our team are specialist welders that have a proven history of welding knowledge and expertise, giving vital input towards ensuring that our machines deliver control and performance to the utmost professional level. We employ an expert team of professional sales, marketing and technical personnel that provide us with market trends, market feedback and customer comments and requirements. Secondly they provide a customer support service that is second to none, thus ensuring our customers have confidence that they will be well satisfied both now and in the future.

RAZORWELD welders are manufactured and compliant with - CAN/CSA E60974-1 & ANSI/IEC 60974-1, guaranteeing you electrical safety and performance.



# **Razorweld®**

## **California Proposition 65**

**WARNING:** This product contains or produces a chemical known to the State of California to cause cancer and birth defects (or other reproductive harm) (California Health and Safety Code Section 25249.5 et seq.)

**WARNING:** This product, when used for welding or cutting, produces fumes or gases which contain chemicals known to the State of California to cause birth defects and, in some cases, cancer (California Health and Safety Code Section 25249.5 et seq.).

### **INFORMATION SOURCES**

- California Health and Safety Code, Section 25249.4 through 25249.13.
- The California Office of Environmental Health Hazard Assessment, 301 Capitol Mall, Sacramento, CA 95814; telephone 916-445-6900.
- California Proposition 65 website: [www.oehha.ca.gov/prop65.html](http://www.oehha.ca.gov/prop65.html).
- American National Standards Institute (ANSI). Product Safety Signs And Labels (ANSI Z535.4), available from ANSI, 25 West 43rd Street, New York, NY 10036; telephone: 212-642-4900; web site: [www.ansi.org](http://www.ansi.org).

## **WARRANTY**

- 3 Years from date of purchase.
- JASIC Technologies America Inc Ltd warranties all goods as specified by the manufacturer of those goods.
- This Warranty does not cover freight or goods that have been interfered with.
- All goods in question must be repaired by an authorised repair agent as appointed by this company.
- Warranty does not cover abuse, mis-use, accident, theft, general wear and tear.
- New product will not be supplied unless JASIC Technologies America Inc has inspected product returned for warranty and agree to replace product.
- Product will only be replaced if repair is not possible
- Please view full Warranty term and conditions supplied with machine or at [www.razorweld.com](http://www.razorweld.com) or at the back of this manual.

<b>CONTENTS</b>	<b>PAGE</b>
Warranty	2
Technical Data, Product Information	4-6
Safety - Cautions	7-9
Machine Layout	10
Installation & Operation for ARC(stick) Welding	11
ARC (Stick) Welding Information	12-13
Installation & Operation for MIG Welding with Gas	14-15
Wire Feed Drive Roller Selection	16
Wire Installation Set up Guide	17
Installation & Operation for MIG Welding with No Gas	18-19
Installation Guide for Mig Torch Liner Installation	20
MIG Torch and Wire Feeder Set Up Guide for Aluminum MIG Wire	21-22
Installation & Operation for MIG Welding with Spool Gun	23-24
MIG (Metal Inert Gas) Welding	25-26
Basic MIG Welding Guide	27-30
Installation & Operation for TIG Welding	31-32
TIG Fusion Technique	33
Tungsten Electrodes & Preparation	34-35
TWC2 MIG Torch Parts Breakdown	36-37
SPGRW200 Spool Gun Torch Parts Breakdown	33-39
SRE TIG Torch Parts Breakdown	40-41
MMA Welding Trouble Shooting Guide	42
MIG Welding Trouble Shooting Guide	43-44
TIG Welding Trouble Shooting Guide	45-46
Warranty	47-49

# Razorweld 145

## MIG-TIG-ARC

**3 YEARS**  
**Warranty**  
 (Power Source)

- MIG, TIG AND ARC Welding machine
- Latest IGBT inverter technology
- MIG/MAG with Gas and Gasless wire function
- Excellent MIG welding with CO2 gas & mixed gas
- Euro style MIG and TIG torch connection
- Internal wire feeder with solid construction
- Adjustable Burn Back
- Spool Gun Connection
- Stepless voltage and wire feed control
- Wire Inch + Smart Set functionality
- Dual voltage 115/230V
- Hot Start - Anti Stick
- Digital Readout
- Solid case construction
- IP21S rating and CSA/CAN Approved



Complete with Torch, Regulator, return and ARC lead set and Adaptor!

## Dual Voltage

Input voltage		Single phase AC230V/115V±15% 50/60Hz			
I <sub>eff</sub>		14A			
I <sub>max</sub>		28A			
Welding wire diameter		0.025/0.03/0.035(in.)			
MIG	Input:115V Output:30A/15.5V 80A/18V	X	25%	60%	100%
		I2	80A	52A	40A
		U2	18V	16.6V	16V
	Input:230V Output:30A/15.5V 145A/21.2V	X	25%	60%	100%
		I2	145A	93.6A	72.5A
		U2	21.2V	18.7V	17.6V
TIG	Input:115V Output:10A/10.4V 80A/13.2V	X	25%	60%	100%
		I2	80A	52A	40A
		U2	13.2V	12.1V	11.6V
	Input:230V Output:10A/10.4V 145A/15.8V	X	25%	60%	100%
		I2	145A	93.6A	72.5A
		U2	15.8V	13.7V	12.9V
ARC	Input:115V Output:10A/20.4V 80A/23.2V	X	25%	60%	100%
		I2	80A	52A	40A
		U2	23.2V	22.1V	21.6V
	Input:230V Output:10A/20.4V 145A/25.8V	X	25%	60%	100%
		I2	145A	93.6A	72.5A
		U2	25.8V	23.7V	22.9V
Dimensions (in)		19.1x7.3x14.6			
Weight Machine (lbs.)		28			

This new RAZORWELD Welder will provide 145 amps of MIG, TIG and ARC output for you to complete your welding jobs! Ideal for the DIY enthusiast, this beautifully designed and highly functional multi-system is a powerful, portable and dual voltage machine ensuring smooth and trouble free welding and backed up by a big 3 year warranty. Our Smart-set function allows you to dial in your preferred wire size and gas mixture and you are ready to start welding! The machine comes complete with Torch, Regulator, Adaptor and Arc lead set.

# Razorweld 180

## MIG-TIG-ARC

- Latest IGBT inverter technology
- MIG/MAG with Gas and Gasless wire function
- Excellent MIG welding with CO2 gas & mixed gas
- Euro style MIG and TIG torch connection
- Internal wire feeder with solid construction
- Adjustable Burn Back
- Spool Gun Connection
- Stepless voltage and wire feed control
- Wire Inch + Smart Set functionality
- MIG, TIG AND ARC Welding machine
- Dual voltage 115/230V
- Hot Start - Anti Stick
- Digital Readout
- Solid case construction
- IP21S rating and CSA/CAN Approved



# 3 YEARS

**Warranty**  
(Power Source)



Complete with Torch, Regulator, return and ARC lead set and Adaptor!

## Dual Voltage

Input voltage (V)		Single phase AC230V/115V±15% (50/60Hz)			
I <sub>eff</sub>		15A			
I <sub>max</sub>		30A			
Welding wire diameter		0.025/0.03/0.035(in.)			
MIG	Input:115V-15A Output:30A/15.5V~80A/18V	X	25%	60%	100%
		I2	100A	64.5A	50A
		U2	19V	17.2V	16.5V
	Input:230V Output:30A/15.5V~180A/23V	X	25%	60%	100%
		I2	180A	116A	90A
		U2	23V	19.8V	18.5V
TIG	Input:115V Output:10A/10.4V~100A/14V	X	25%	60%	100%
		I2	100A	64.5A	50A
		U2	14V	12.6V	12V
	Input:230V Output:10A/10.4V~180A/17.2V	X	25%	60%	100%
		I2	180A	116A	90A
		U2	17.2V	14.6V	13.6V
ARC	Input:115V-20A Output:10A/20.4V~100A/24V	X	25%	60%	100%
		I2	100A	64.5A	50A
		U2	24V	22.6V	22V
	Input:230V Output:10A/20.4V~160A/26.4V	X	25%	60%	100%
		I2	160A	103A	80A
		U2	26.4V	24.1V	23.2V
Dimensions (in.)		19.1×7.3×14.6			
Weight		28.4 Pounds (Machine)			

This new RAZORWELD Welder will provide 180 amps of MIG, TIG and ARC output for you to complete your welding jobs! Ideal for the serious tradesman, this beautifully designed and highly functional multi-system is a powerful, portable and dual voltage machine ensuring smooth and trouble free welding and backed up by a big 3 year warranty. Our Smart-set function allows you to dial in your preferred wire size and gas mixture and you are ready to start welding! The machine comes complete with Torch, Regulator, Adaptor and Arc lead set. A real workhorse with a high duty Cycle.!

# Razorweld 210

## MIG-TIG-ARC

**3 YEARS**  
**Warranty**  
 (Power Source)

- Latest IGBT inverter technology
- MIG/MAG with Gas and Gasless wire function
- Excellent MIG welding with CO2 gas & mixed gas
- Euro style MIG and TIG torch connection
- Internal wire feeder with solid construction
- Adjustable Burn Back
- Spool Gun Connection
- Stepless voltage and wire feed control
- Wire Inch + Smart Set functionality
- MIG, TIG AND ARC Welding machine
- Dual voltage 115/230V
- Hot Start - Anti Stick
- Digital Readout
- Solid case construction
- IP21S rating and CSA/CAN Approved



Complete with Torch, Regulator, return and ARC lead set and Adaptor!

## Dual Voltage

Input voltage (V)		Single phase AC230V/115V±15% (50/60Hz)			
I <sub>eff</sub>		115V 21A / 230V 22A			
I <sub>max</sub>		115V 42A / 230V 44A			
Welding wire diameter		0.025/0.03/0.035(in.)			
MIG	Input:115V Output:30A/15.5V~120A/20V	X	25%	60%	100%
		I2	120A	77.5A	60A
		U2	20V	17.9V	17V
	Input:230V Output:30A/15.5V~150A/21.5V	X	25%	60%	100%
		I2	210A	136A	105A
		U2	24.5V	20.8V	19.3V
TIG	Input:115V Output:10A/10.4V~120A/14.8V	X	25%	60%	100%
		I2	120A	77.5A	60A
		U2	14.8V	13.1V	12.4V
	Input:230V Output:10A/10.4V~210A/18.4V	X	25%	60%	100%
		I2	210A	136A	105A
		U2	18.4V	15.4V	14.2V
ARC	Input:115V Output:10A/20.4V~120A/24.8V	X	25%	60%	100%
		I2	120A	77.5A	60A
		U2	24.8V	23.1V	22.4V
	Input:230V Output:10A/20.4V~210A/18.4V	X	20%	60%	100%
		I2	210A	136A	105A
		U2	18.4V	15.4V	14.2V
Dimensions (in.)		19.1x7.3x14.6			
Weight		28.4 Pounds (Machine)			

This new RAZORWELD Welder will provide 210 amps of MIG, TIG and ARC output for you to complete your welding jobs! Ideal for the serious tradesman, this beautifully designed and highly functional multi-system is a powerful, portable and dual voltage machine ensuring smooth and trouble free welding and backed up by a big 3 year warranty. Our Smart-set function allows you to dial in your preferred wire size and gas mixture and you are ready to start welding! The machine comes complete with Torch, Regulator, Adaptor and Arc lead set. A real workhorse with a high duty Cycle!

# SAFETY

Welding and cutting equipment can be dangerous to both the operator and people in or near the surrounding working area, if the equipment is not correctly operated. Equipment must only be used under the strict and comprehensive observance of all relevant safety regulations. Read and understand this instruction manual carefully before the installation and operation of this equipment.

## Machine Operating Safety

- Do not switch the function modes while the machine is operating. Switching of the function modes during welding can damage the machine. Damage caused in this manner will not be covered under warranty.
- Disconnect the electrode-holder cable from the machine before switching on the machine, to avoid arcing should the electrode be in contact with the work piece.
- Operators should be trained and or qualified.



**Electric shock: It can kill.** Touching live electrical parts can cause fatal shocks or severe burns. The electrode and work circuit is electrically live whenever the output is on. The input power circuit and internal machine circuits are also live when power is on. In Mig/Mag welding, the wire, drive rollers, wire feed housing, and all metal parts touching the welding wire are electrically live. Incorrectly installed or improperly grounded equipment is dangerous.

- Connect the primary input cable according to United States standards and regulations.
- Avoid all contact with live electrical parts of the welding circuit, electrodes and wires with bare hands. The operator must wear dry welding gloves while he/she performs the welding task.
- The operator should keep the work piece insulated from himself/herself.
- Keep cords dry, free of oil and grease, and protected from hot metal and sparks.
- Frequently inspect input power cable for wear and tear, replace the cable immediately if damaged, bare wiring is dangerous and can kill.
- Do not use damaged, under sized, or badly joined cables.
- Do not drape cables over your body.
- We recommend (RCD) safety switch is used with this equipment to detect any leakage of current to earth.



**Fumes and gases are dangerous.** Smoke and gas generated whilst welding or cutting can be harmful to people's health. Welding produces fumes and gases. Breathing these fumes and gases can be hazardous to your health.

- Do not breathe the smoke and gas generated whilst welding or cutting, keep your head out of the fumes
- Keep the working area well ventilated, use fume extraction or ventilation to remove welding fumes and gases.
- In confined or heavy fume environments always wear an approved air-supplied respirator. Welding fumes and gases can displace air and lower the oxygen level causing injury or death. Be sure the breathing air is safe.
- Do not weld in locations near de-greasing, cleaning, or spraying operations. The heat and rays of the arc can react with vapours to form highly toxic and irritating gases.
- Materials such as galvanized, lead, or cadmium plated steel, containing elements that can give off toxic fumes when welded. Do not weld these materials unless the area is very well ventilated, and or wearing an air supplied respirator.



**Arc rays: harmful to people's eyes and skin.** Arc rays from the welding process produce intense visible and invisible ultraviolet and infrared rays that can burn eyes and skin.

- Always wear a welding helmet with correct shade of filter lens and suitable protective clothing including welding gloves whilst the welding operation is performed.
- Measures should be taken to protect people in or near the surrounding working area. Use protective screens or barriers to protect others from flash, glare and sparks; warn others not to watch the arc.



**Fire hazard.** Welding on closed containers, such as tanks, drums, or pipes, can cause them to explode. Flying sparks from the welding arc, hot work piece, and hot equipment can cause fires and burns. Accidental contact of electrode to metal objects can cause sparks, explosion, overheating, or fire. Check and be sure the area is safe before doing any welding.

- The welding sparks & spatter may cause fire, therefore remove any flammable materials well away from the working area. Cover flammable materials and containers with approved covers if unable to be moved from the welding area.
- Do not weld on closed containers such as tanks, drums, or pipes, unless they are properly prepared according to the required Safety Standards to insure that flammable or toxic vapors and substances are totally removed, these can cause an explosion even though the vessel has been “cleaned”.  
Vent hollow castings or containers before heating, cutting or welding. They may explode.
- Do not weld where the atmosphere may contain flammable dust, gas, or liquid vapours (such as petrol)
- Have a fire extinguisher nearby and know how to use it. Be alert that welding sparks and hot materials from welding can easily go through small cracks and openings to adjacent areas. Be aware that welding on a ceiling, floor, bulkhead, or partition can cause fire on the hidden side.



**Gas Cylinders.** Shielding gas cylinders contain gas under high pressure. If damaged, a cylinder can explode. Because gas cylinders are normally part of the welding process, be sure to treat them carefully. **CYLINDERS** can explode if damaged.

- Protect gas cylinders from excessive heat, mechanical shocks, physical damage, slag, open flames, sparks, and arcs.
- Insure cylinders are held secure and upright to prevent tipping or falling over.
- Never allow the welding electrode or earth clamp to touch the gas cylinder, do not drape welding cables over the cylinder.
- Never weld on a pressurised gas cylinder, it will explode and kill you.
- Open the cylinder valve slowly and turn your face away from the cylinder outlet valve and gas regulator.



**Gas build up.** The build up of gas can causes a toxic environment, deplete the oxygen content in the air resulting in death or injury. Many gases use in welding are invisible and odourless.

- Shut off shielding gas supply when not in use.
- Always ventilate confined spaces or use approved air-supplied respirator.

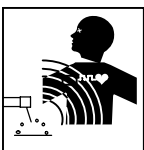

**Electronic magnetic fields.** **MAGNETIC FIELDS** can affect Implanted Medical Devices.

- Wearers of Pacemakers and other Implanted Medical Devices should keep away.
- Implanted Medical Device wearers should consult their doctor and the device manufacturer before going near any electric welding, cutting or heating operation.



**Noise can damage hearing.** Noise from some processes or equipment can damage hearing. Wear approved ear protection if noise level is high.



**Hot parts.** Items being welded generate and hold high heat and can cause severe burns. Do not touch hot parts with bare hands. Allow a cooling period before working on the welding gun. Use insulated welding gloves and clothing to handle hot parts and prevent burns.



# CAUTION

## 1. Working Environment.

- 1.1 The environment in which this welding equipment is installed must be free of grinding dust, corrosive chemicals, flammable gas or materials etc, and at no more than maximum of 80% humidity.
- 1.2 When using the machine outdoors protect the machine from direct sun light, rain water and snow etc; the temperature of working environment should be maintained within 14°F to +104°F.
- 1.3 Keep this equipment 12" distant from the wall.
- 1.4 Ensure the working environment is well ventilated.

## 2. Safety Tips.

### 2.1 Ventilation

This equipment is small-sized, compact in structure, and of excellent performance in amperage output. The fan is used to dissipate heat generated by this equipment during the welding operation.

**Important:** Maintain good ventilation of the louvers of this equipment. The minimum distance between this equipment and any other objects in or near the working area should be 12". Good ventilation is of critical importance for the normal performance and service life of this equipment.

### 2.2 Thermal Overload protection.

Should the machine be used to an excessive level, or in high temperature environment, poorly ventilated area or if the fan malfunctions the Thermal Overload Switch will be activated and the machine will cease to operate. Under this circumstance, leave the machine switched on to keep the built-in fan working to bring down the temperature inside the equipment. The machine will be ready for use again when the internal temperature reaches safe level.

### 2.3 Over-Voltage Supply

Regarding the power supply voltage range of the machine, please refer to "Main parameter" table. This equipment is of automatic voltage compensation, which enables the maintaining of the voltage range within the given range. In case that the voltage of input power supply amperage exceeds the stipulated value, it is possible to cause damage to the components of this equipment. Please ensure your primary power supply is correct.

- 2.4 Do not come into contact with the output terminals while the machine is in operation. An electric shock may possibly occur.

# MAINTENANCE

Exposure to extremely dusty, damp, or corrosive air is damaging to the welding machine. In order to prevent any possible failure or fault of this welding equipment, clean the dust at regular intervals with clean and dry compressed air of required pressure.

**Please note that:** lack of maintenance can result in the cancellation of the guarantee; the guarantee of this welding equipment will be void if the machine has been modified, attempt to take apart the machine or open the factory-made sealing of the machine without the consent of an authorized representative of the manufacturer.

# TROUBLE SHOOTING

Caution: Only qualified technicians are authorized to undertake the repair of this welding equipment. For your safety and to avoid Electrical Shock, please observe all safety notes and precautions detailed in this manual.

## Note:

Minimum Motor Generator Power Suggested: 9.4KVA for MIG210

## FRONT PANEL LAYOUT

1. Digital Volts Meter
2. Digital Amps Meter
3. 2T/4T Selector Button
4. Wire Speed / Amps Adjustment Knob
5. Voltage / Downslope / ARC Force Adjustment Knob
6. MIG / TIG / MMA / Smartset Selector Knob
7. “-” Output terminal
8. Euro MIG / TIG Torch Connector (MIG/MAG)
9. “+” Output terminal
10. SpoolGun Power Supply Connection



## BACK PANEL LAYOUT

11. Power switch
12. Gas Inlet
13. Fan
14. Input power cable
15. Data Plate



## INTERNAL PANEL LAYOUT

16. Spoolgun/Standard selector switch
17. Inch wire feed button
18. Gas Check button
19. Spool holder assembly
20. Geared Wire feed assembly

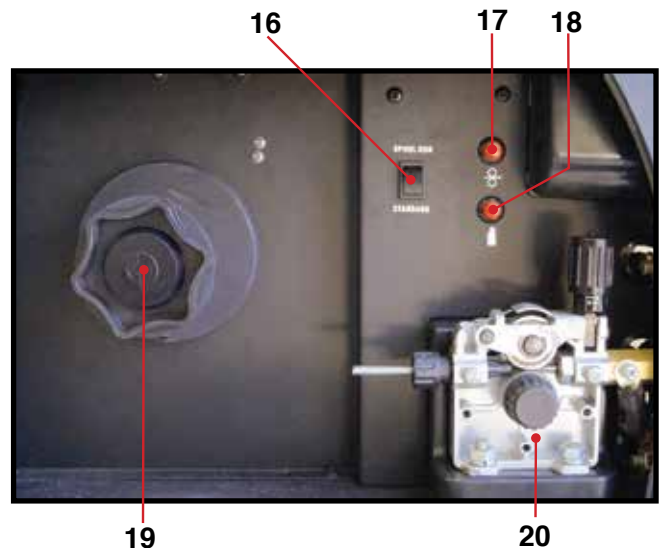

# Installation set up for ARC (Stick) Welding with RAZOR 210

## 1) Connection of Output Cables

Two sockets are available on this welding machine. For ARC welding the electrode holder is shown be connected to the negative socket, while the earth lead (work piece) is connected to the positive socket, this is known as DC- polarity. However various electrodes require a different polarity for optimum results and careful attention should be paid to the polarity, refer to the electrode manufacturers information for the correct polarity.

**DC+** Electrode connected to  $\oplus$  output socket.

**DC-** Electrode connected to  $\ominus$  output socket.

(2) Turn the power source on and select the **ARC** function with the MIG/TIG/ARC selector switch.

(3) Set the welding current relevant to the electrode type and size being used as recommended by the electrode manufacturer.



(2) Set MIG/TIG/ARC selector switch to MMA

(1) Connect the earth lead to  $\oplus$

(1) Connect the electrode lead to  $\ominus$



(3) Set the welding current using the amperage control dial, and adjust arcforce if required



(4) Place the electrode into the electrode holder and clamp tight.



(5) Strike the electrode against the workpiece to create an arc and hold the electrode steady to maintain the arc.



(6) Hold the electrode slightly above the work maintaining the arc while travelling at an even speed.



(7) To finish the weld, break the arc by quickly snapping the electrode away from the work piece.

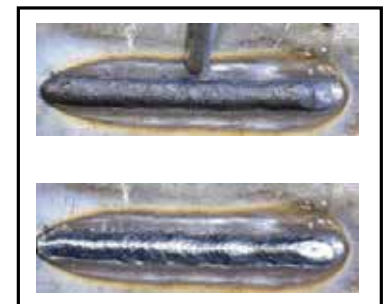

(8) Wait for the weld to cool and carefully chip away the slag to reveal the weld metal below.

# ARC Welding

One of the most common types of arc welding is manual metal arc welding (MMA) or stick welding. An electric current is used to strike an arc between the base material and a consumable electrode rod or 'stick'. The electrode rod is made of a material that is compatible with the base material being welded and is covered with a flux that gives off gaseous vapours that serve as a shielding gas and providing a layer of slag, both of which protect the weld area from atmospheric contamination. The electrode core itself acts as filler material the residue from the flux that forms a slag covering over the weld metal must be chipped away after welding.

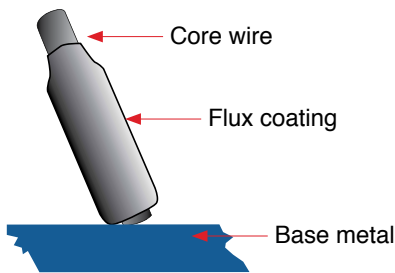
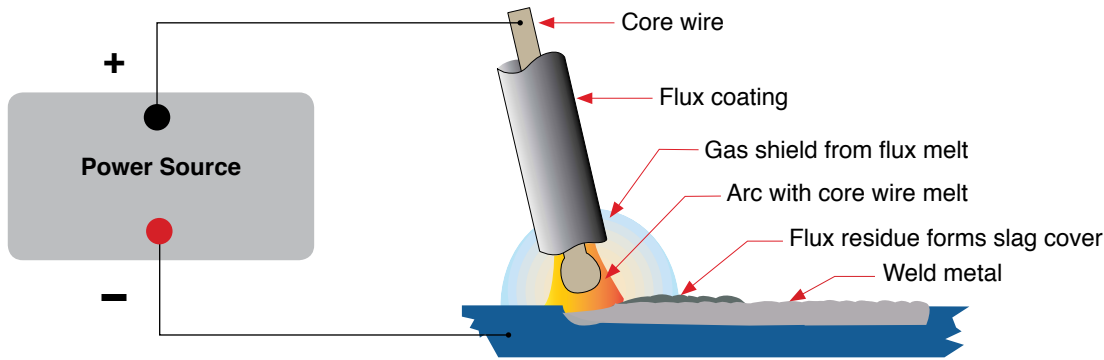

- The arc is initiated by momentarily touching the electrode to the base metal.
- The heat of the arc melts the surface of the base metal to form a molten pool at the end of the electrode.
- The melted electrode metal is transferred across the arc into the molten pool and becomes the deposited weld metal.
- The deposit is covered and protected by a slag which comes from the electrode coating.
- The arc and the immediate area are enveloped by an atmosphere of protective gas

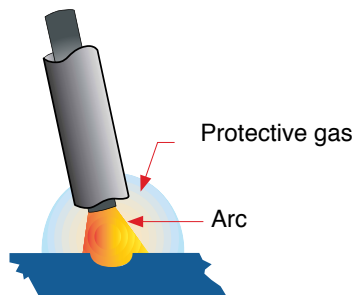

Manual metal arc (stick) electrodes have a solid metal wire core and a flux coating. These electrodes are identified by the wire diameter and by a series of letters and numbers. The letters and numbers identify the metal alloy and the intended use of the electrode.

The **Metal Wire Core** works as conductor of the current that maintains the arc. The core wire melts and is deposited into the welding pool.

The covering on a shielded metal arc welding electrode is called **Flux**. The flux on the electrode performs many different functions. These include:

- producing a protective gas around the weld area
- providing fluxing elements and deoxidizers
- creating a protective slag coating over the weld as it cools
- establishing arc characteristics
- adding alloying elements.

Covered electrodes serve many purposes in addition to adding filler metal to the molten pool. These additional functions are provided mainly by the covering on the electrode.

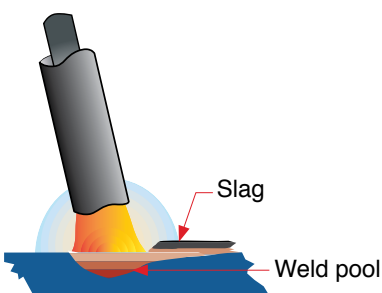

# ARC Welding Fundamentals

## Electrode Selection

As a general rule, the selection of an electrode is straight forward, in that it is only a matter of selecting an electrode of similar composition to the parent metal. However, for some metals there is a choice of several electrodes, each of which has particular properties to suit specific classes of work. It is recommended to consult your welding supplier for the correct selection of electrode.

## Electrode Size

Average Thickness of Material	Maximum Recommended Electrode Diameter
0.03 - 0.07 inches	0.09 inches
0.07 - 0.19 inches	0.12 inches
0.19 - 0.31 inches	0.15 inches
0.31 - > inches	0.19 inches

The size of the electrode generally depends on the thickness of the section being welded, and the thicker the section the larger the electrode required. The table gives the maximum size of electrodes that may be used for various thicknesses of section based on using a general purpose type 6013 electrode.

## Welding Current (Amperage)

Electrode Size $\phi$ mm	Current Range (Amps)
0.09 inches	60 - 100
0.12 inches	100 - 130
0.15 inches	130 - 165
0.19 inches	165 - 260

Correct current selection for a particular job is an important factor in arc welding. With the current set too low, difficulty is experienced in striking and maintaining a stable arc. The electrode tends to stick to the work, penetration is poor and beads with a distinct rounded profile will be deposited. Too high current is accompanied by overheating of the electrode resulting in undercut and burning through of the base metal and producing excessive spatter. Normal current for a particular job

may be considered as the maximum, which can be used without burning through the work, overheating the electrode or producing a rough spattered surface.

The table shows current ranges generally recommended for a general purpose type 6013 electrode.

## Arc Length

To strike the arc, the electrode should be gently scraped on the work until the arc is established. There is a simple rule for the proper arc length; it should be the shortest arc that gives a good surface to the weld. An arc too long reduces penetration, produces spatter and gives a rough surface finish to the weld. An excessively short arc will cause sticking of the electrode and result in poor quality welds. General rule of thumb for down hand welding is to have an arc length no greater than the diameter of the core wire.

## Electrode Angle

The angle that the electrode makes with the work is important to ensure a smooth, even transfer of metal. When welding in down hand, fillet, horizontal or overhead the angle of the electrode is generally between 5 and 15 degrees towards the direction of travel. When vertical up welding the angle of the electrode should be between 80 and 90 degrees to the work piece.

## Travel Speed

The electrode should be moved along in the direction of the joint being welded at a speed that will give the size of run required. At the same time, the electrode is fed downwards to keep the correct arc length at all times. Excessive travel speeds lead to poor fusion, lack of penetration etc, while too slow a rate of travel will frequently lead to arc instability, slag inclusions and poor mechanical properties.

## Material and Joint Preparation

The material to be welded should be clean and free of any moisture, paint, oil, grease, mill scale, rust or any other material that will hinder the arc and contaminate the weld material. Joint preparation will depend on the method used include sawing, punching, shearing, machining, flame cutting and others. In all cases edges should be clean and free of any contaminants. The type of joint will be determined by the chosen application.

## Installation set up for MIG with Gas for RAZOR 210

- (1) Connect Mig Torch **IMPORTANT** : When connecting the torch be sure to tighten the connection.
- (2) Connect the earth lead to **Negative** socket
- (3) Connect the weld power lead to **Positive** socket
- (4) Turn the power source on and select the **MIG** function with the MIG/TIG/MMA selector switch.  
Or Select **Smartset** this is a predefined setting based on Gas and wire used. The machine will preselect voltage and wire speed allowing the user to quickly find the best welding parameters
- (5) Set torch operation 2T / 4T.
  - When 2T operation is selected press trigger Arc starts, release trigger, Arc stops. burnback operation is automatic and preset.
  - When 4T operation is selected press and release trigger Arc starts, press and release trigger Arc stops. burnback operation is automatic and preset.



**SmartSet** by RazorWeld® makes welding easy by taking the guess work out of MIG machine settings. Simply select the correct wire diameter and gas type that you're using then dial in your desired wire feed speed for the job. Use more wire speed for thicker material and less wire speed for thinner material. The SmartSet system will auto-adjust the welding voltage to give you an ideal arc condition while welding. SmartSet also allows you to fine tune the auto-adjusted voltage to personalise your setting for optimal results.



(5) Select torch operation 2T or 4T

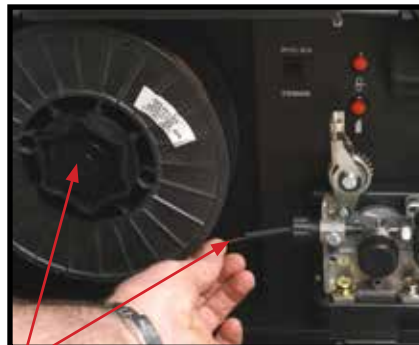

(7) Place wire onto spool holder - (spool retaining nut is left hand thread ) Feed the wire through the inlet guide tube on to the drive roller.

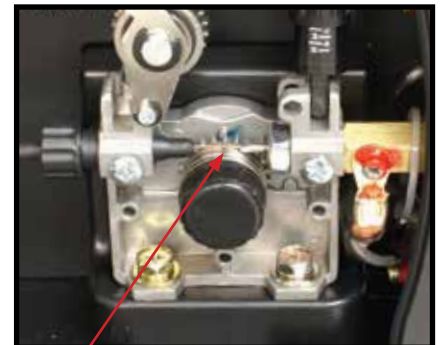

(8) Feed wire over the drive roller into the outlet guide tube, Push the wire through approx 4-5in.

**WARNING:**  
Ensure that an approved welding helmet, protective clothing and gloves are use for all welding operations

**WARNING:**  
Disconnect the Electrode Holder cable from the machine before using MIG function. If cable is not disconnected welding voltage is present and can cause arcing or flash.

## Continued set up for MIG with Gas for RAZOR 210

- (7) Place wire onto spool holder - (spool retaining nut is left hand thread )  
Feed the wire through the inlet guide tube on to the drive roller.
- (8) Feed wire over the drive roller into the outlet guide tube, Push the wire through approx 3-4in
- (9) Align the wire into the groove of the drive roller and close down the top roller making sure the wire is in the groove of the bottom drive roller, lock the pressure arm into place.
- (10) Apply a medium amount of pressure to the drive roller.
- (11) Remove the gas nozzle and contact tip from the torch neck,
- (12) Press and hold the inch button to feed the wire through to the torch neck, release the inch button when the wire exits the torch neck.
- (13) Fit the correct sized contact tip and feed the wire through it,  
screw the contact tip into the tip holder of the torch head and nip it up tightly.
- (14) Fit the gas nozzle to the torch head.
- (15) Carefully open the gas cylinder valve and set the flow rate to between 11-21cfh.
- (16) Set the welding parameters using the wire feed and voltage control knobs.

**NOTE: WIRE FEED SPEED TAKES EFFECT ONLY WHEN ARC IS STRUCK.**

- (17) Or use Smartset, Smartset is a predefined setting based on Gas and wire used.  
The machine will preselect Voltage and wire speed allowing the user to quickly find the best welding parameters for a given metal.

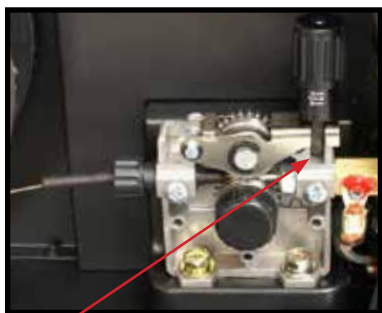

(9) Close down the top roller bracket and clip the pressure arm into place.



(10) Apply a medium amount of pressure to the drive roller

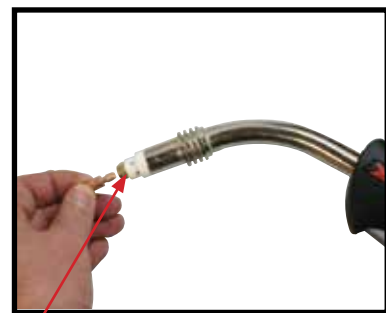

(11) Remove the gas nozzle and contact tip from the front end of the mig torch.



(12) Press and hold the inch wire button to feed the wire down the torch cable through to the torch head.

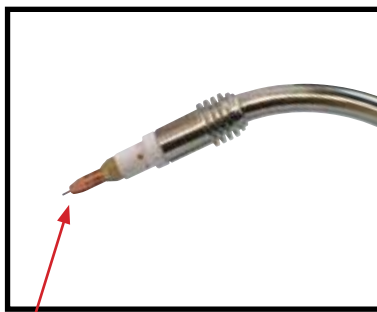

(13) Fit the correct size contact tip over the wire and fasten tightly into the tip holder.

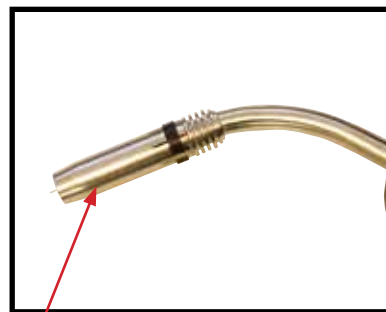

(14) Fit the gas nozzle to the torch head.

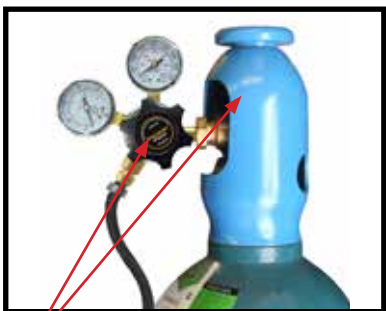

(15) Carefully open the valve of the gas cylinder, set the flow to 21cfh



(16) Set welding parameters using the voltage and wire feed controls.

**NOTE: WIRE FEED SPEED TAKES EFFECT ONLY WHEN ARC IS STRUCK**



(17) Smartset is a predefined setting based on Gas and wire used. The machine will preselect Voltage and wire speed allowing the user to quickly find the best welding parameters for a given metal.

**NOTE:**  
GEAR DRIVE FEEDER ON 210 MODEL ONLY

## Wire Feed Roller Selection

The importance of smooth consistent wire feeding during MIG welding cannot be emphasized enough. Simply put the smoother the wire feed then the better the welding will be.

Feed rollers or drive rollers are used to feed the wire mechanically along the length of the welding gun. Feed rollers are designed to be used for certain types of welding wire and they have different types of grooves machined in them to accommodate the different types of wire. The wire is held in the groove by the top roller of the wire drive unit and is referred to as the pressure roller, pressure is applied by a tension arm that can be adjusted to increase or decrease the pressure as required. The type of wire will determine how much pressure can be applied and what type of drive roller is best suited to obtain optimum wire feed. **Solid Hard Wire** - like Steel, Stainless Steel require a drive roller with a V shape groove for optimum grip and drive capability. Solid wires can have more tension applied to the wire from the top pressure roller that holds the wire in the groove and the V shape groove is more suited for this. Solid wires are more forgiving to feed due to their higher cross sectional column strength, they are stiffer and don't bend so easy.

**Soft Wire** - like Aluminium requires a U shape groove. Aluminium wire has a lot less column strength, can bend easily and is therefore more difficult to feed. Soft wires can easily buckle at the wire feeder where the wire is fed into inlet guide tube of the torch. The U-shaped roller offers more surface area grip and traction to help feed the softer wire. Softer wires also require less tension from the top pressure roller to avoid deforming the shape of the wire, too much tension will push the wire out of shape and cause it to catch in the contact tip.

**Flux Core / Gasless Wire** - these wires are made up of a thin metal sheath that has fluxing and metal compounds layered onto it and then rolled into a cylinder to form the finished wire. The wire cannot take too much pressure from the top roller as it can be crushed and deformed if too much pressure is applied. A knurled drive roller has been developed and it has small serrations in the groove, the serrations grip the wire and assist to drive it without too much pressure from the top roller. The down side to the knurled wire feed roller on flux cored wire is it will slowly over time bit by bit eat away at the surface of the welding wire, and these small pieces will eventually go down into the liner. This will cause clogging in the liner and added friction that will lead to welding wire feed problems. A U groove wire can also be used for flux core wire without the wire particles coming off the wire surface. However it is considered that the knurled roller will give a more positive feed of flux core wire without any deformation of the wire shape.

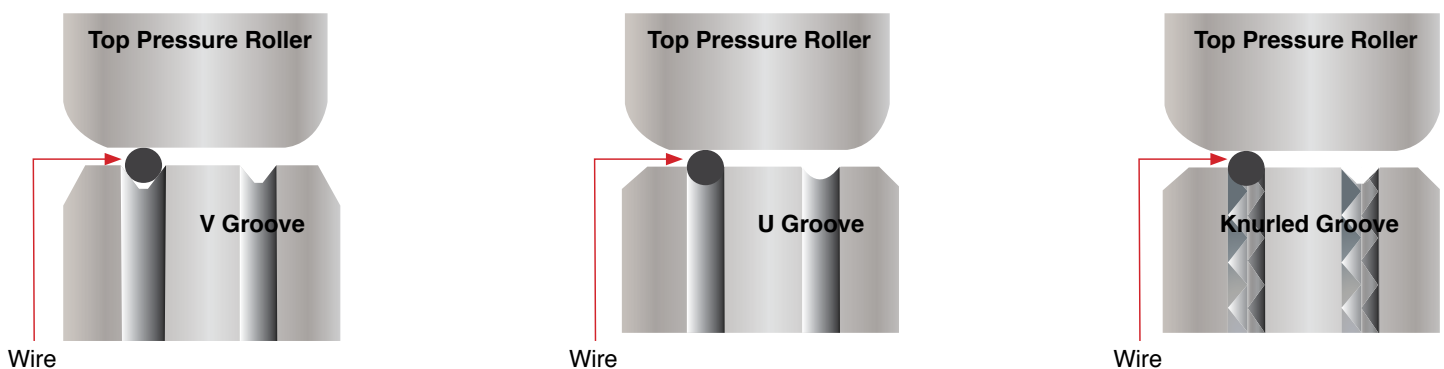

## Drive Rollers

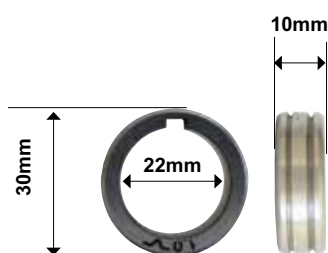

### MIG145/180

### MIG210 Drive roller sizes

V Groove Drive Roller - Steel Wire		
Part Number	Part Number	Description
0.6-0.8V30/10	0.6-0.8V30/22	Drive Roll V Groove 0.6-0.8mm / 0.023" - 0.030"
0.8-1.0V30/10	0.8-1.0V30/22	Drive Roll V Groove 0.8-1.0mm / 0.030" - 0.040"
0.9-1.2V30/10	0.9-1.2V30/22	Drive Roll V Groove 0.9-1.2mm / 0.035" - 0.045"
1.0-1.2V30/10	1.0-1.2V30/22	Drive Roll V Groove 1.0-1.2mm / 0.040" - 0.045"
	1.2-1.6V30/22	Drive Roll V Groove 1.2-1.6mm / 0.045" - 0.062"
Knurled Drive Roller - Flux Core Wire		
Part Number	Part Number	Description
0.6-0.8F30/10	0.6-0.8F30/22	Drive Roll Knurled 0.6-0.9mm / 0.023" - 0.035"
0.8-0.9F30/10	0.8-0.9F30/22	Drive Roll Knurled 0.8-0.9mm / 0.030" - 0.035"
0.9-1.2F30/10	0.9-1.2F30/22	Drive Roll Knurled 0.9-1.2mm / 0.035" - 0.045"
	1.2-1.6F30/22	Drive Roll Knurled 1.2-1.6mm / 0.045" - 0.062"
U Groove Drive Roller - Soft Wire		
Part Number	Part Number	Description
0.8-1.0U30/10	0.8-1.0U30/22	Drive Roll U Groove 1.0-1.2mm / 0.040" - 0.045"
0.9-1.0U30/10	0.9-1.0U30/22	Drive Roll U Groove 0.9-1.0mm / 0.035" - 0.040"
0.9-1.2U30/10	0.9-1.2U30/22	Drive Roll U Groove 0.9-1.2mm / 0.035" - 0.045"
1.0-1.2U30/10	1.0-1.2U30/22	Drive Roll U Groove 1.0-1.2mm / 0.040" - 0.045"



## Wire Installation and Set Up Guide

Again the importance of smooth consistent wire feeding during MIG welding cannot be emphasized enough. The correct installation of the wire spool and the wire into the wire feed unit is critical to achieving an even and consistent wire feed. A high percentage of faults with mig welders emanate from poor set up of the wire into the wire feeder. The guide below will assist in the correct setup of your wire feeder.



**(1)** Remove the spool retaining nut.



**(2)** Note the tension spring adjuster and spool locating pin.

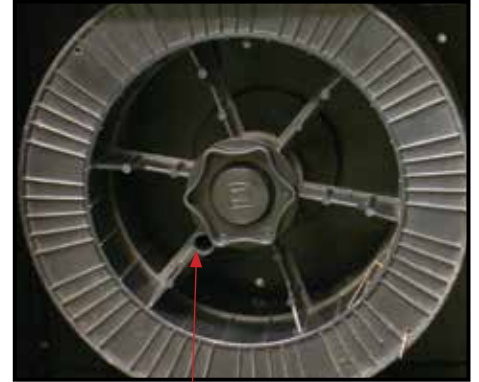

**(3)** Fit the wire spool onto the spool holder fitting the locating pin into the location hole on the spool. Replace the spool retaining nut tightly



**(4)** Snip the wire carefully, be sure to hold the wire to prevent the spool uncoiling. Carefully feed the wire into the inlet guide tube of the wire feed unit.

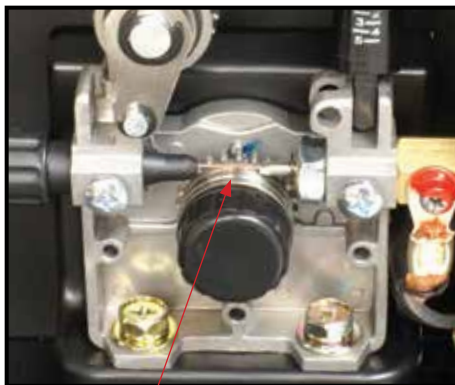

**(5)** Feed the wire through the drive roller and into the outlet guide tube of the wire feeder.  
NOTE: MIG 180-145 not geared

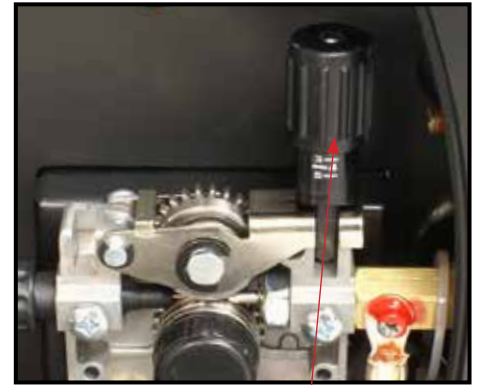

**(6)** Lock down the top pressure roller and apply a medium amount of pressure using the tension adjustment knob  
NOTE: MIG 180-145not geared

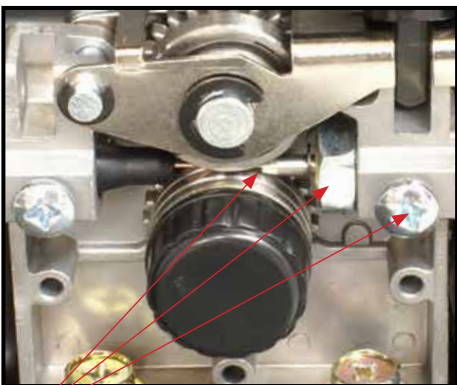

**(7)** Check that the wire passes through the centre of the outlet guide tube without touching the sides. Loosen the locking screw and then loosen the outlet guide tube retaining nut too make adjustment if required. Carefully retighten the locking nut and screw to hold the new position.  
NOTE: MIG 180-145 not geared



**(8)** A simple check for the correct drive tension is to bend the end of the wire over hold it about 4in from your hand and let it run into your hand, it should coil round in your hand without stopping and slipping at the drive rollers, increase the tension if it slips.



**(8)** The weight and speed of the wire spool turning creates an inertia that can cause the spool to run on and the wire loop over the side of the spool and tangle. if this happens increase the pressure on the tension spring inside the spool holder assembly using the tension adjustment screw.

## Installation set up for MIG with Gasless for RAZOR 210

- (1) Connect Mig Torch  
**IMPORTANT** : When connecting the torch be sure to tighten the connection. Additionally Digital MIG torch must be connected prior to power being turned on otherwise remote control will not work
- (2) Connect the earth lead to **Positive** socket
- (3) Connect the weld power lead to **Negative** socket
- (4) Turn the power source on and select the **MIG** function with the MIG/TIG/MMA selector switch.
- (5) Set torch operation 2T / 4T.
  - When 2T operation is selected press trigger Arc starts, release trigger, Arc stops. burnback operation is automatic and preset.
  - When 4T operation is selected press and release trigger Arc starts, press and release trigger Arc stops. burnback operation is automatic and preset..
- (6) Fit the correct size **Knurled** drive roller for Gas Less Flux Core wire.



(5) Select torch operation 2T or 4T



(6) Fit the correct sized Knurled Drive roller for Gas Less Flux Cored wire



(7) Place wire onto spool holder - (spool retaining nut is left hand thread ) Feed the wire through the inlet guide tube on to the drive roller.

**WARNING:**

Ensure that an approved welding helmet, protective clothing and gloves are use for all welding operations

**WARNING:**

Disconnect the Electrode Holder cable from the machine before using MIG function. If cable is not disconnected welding voltage is present and can cause arcing or flash.

## Continued set up for MIG with Gasless wire for RAZOR 210

- (7) Place the Wire Spool onto the Spool Holder - Note: the spool retaining nut is Left Hand thread. Snip the wire from the spool being sure to hold the wire to prevent rapid uncoiling. Feed the wire into the wire feeder inlet guide tube through to the drive roller.
- (8) Carefully feed the wire over the drive roller into the outlet guide tube, feed through about 8-9in into the torch receptacle. .
- (9) Align the wire into the groove of the drive roller and close down the top roller making sure the wire is in the groove of the bottom drive roller, lock the pressure arm into place.
- (10) Apply a light amount of pressure to the drive roller. Too much pressure will crush the cored wire.
- (11) Remove the gas nozzle and contact tip from the torch neck,
- (12) Press and hold the inch button to feed the wire through to the torch neck, release the inch button when the wire exits the torch neck.
- (13) Fit the correct sized contact tip and feed the wire through it, screw the contact tip into the tip holder of the torch head and nip it up tightly.
- (14) Fit the gas nozzle to the torch head.
- (15) Set the welding parameters using the wire feed and voltage control knobs.

**NOTE: WIRE FEED SPEED TAKES EFFECT ONLY WHEN ARC IS STRUCK.**



(8) Feed wire over the drive roller into the outlet guide tube, Push the wire through approx 8-9in. Use a Knurled Drive Roller of the correct size



(9) Close down the top roller bracket and clip the pressure arm into place.

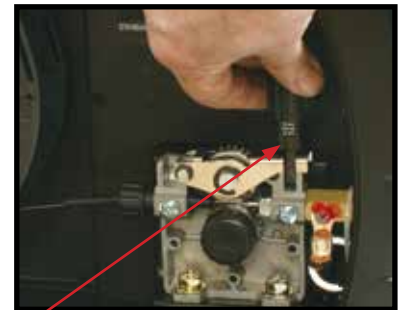

(10) Apply a medium amount of pressure to the drive roller

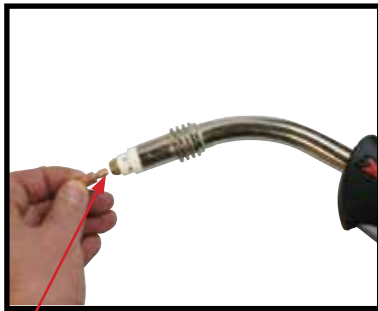

(11) Remove the gas nozzle and contact tip from the front end of the mig torch.



(12) Press and hold the inch wire button to feed the wire down the torch cable through to the torch head.

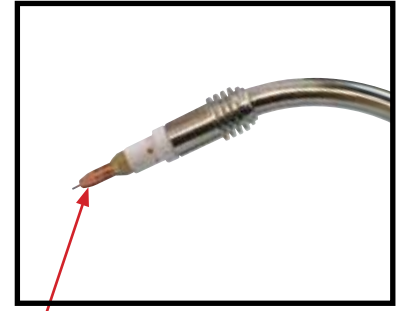

(13) Fit the correct size contact tip over the wire and fasten tightly into the tip holder.

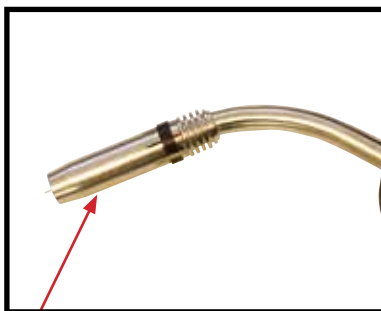

(14) Fit the gas nozzle to the torch head.



(15) Set welding parameters using the voltage and wire feed controls.

**NOTE: WIRE FEED SPEED TAKES EFFECT ONLY WHEN ARC IS STRUCK**

**NOTE:**

GEAR DRIVE FEEDER ON 210 MODEL ONLY

## Mig Torch Liner Installation

- (1) Lay the torch out straight on the ground and remove the front end parts
- (2) Remove the liner retaining nut.
- (3) Carefully pull the liner out of the torch cable assembly
- (4) Select the correct new liner and carefully unravel avoiding putting any kinks in the liner, if you kink the liner it will make it no good and will require replacement.
- (5) Carefully and slowly feed the liner in short forward movements down the cable assembly all the way through and out the torch neck end. Avoid kinking the liner, kinking liner it will make it no good and require replacement.
- (6) Fit the liner retaining nut and screw down only 1/2 way
- (7) Leaving the torch straight snip the liner approximately 1/8in past the end of the torch neck
- (8) Place the tip holder over the end of the liner and screw into the torch neck trimming it up tight.
- (9) Screw down the liner nut the remaining 1/2 and trim it up tight. This method compresses the liner inside the torch cable assembly preventing it moving during use and ensures good wire feed.

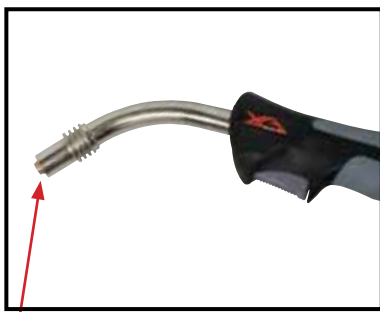

(1) Remove mig torch front end parts

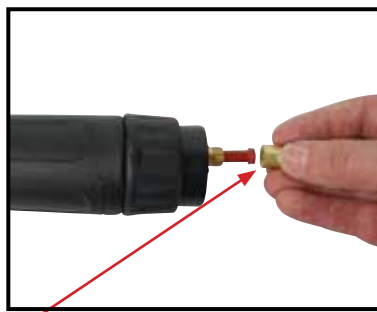

(2) Remove the liner retaining nut

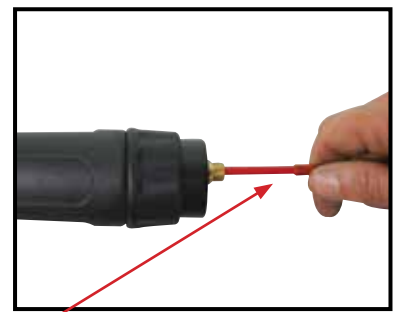

(3) Carefully pull out and completely remove the liner

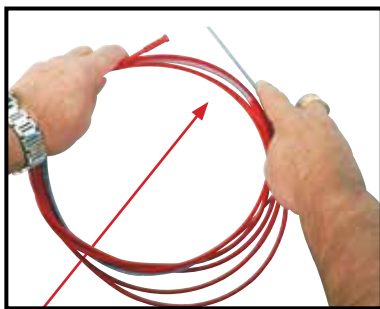

(4) Carefully unravel the new liner

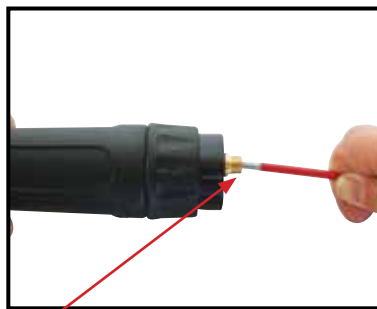

(5) Carefully feed in the new liner down the torch lead all the way to exit the torch neck.

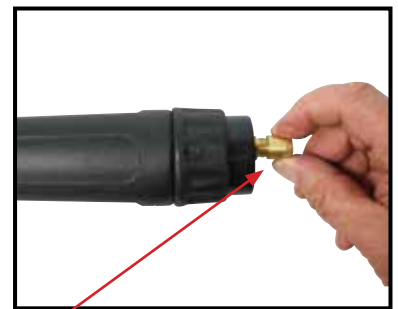

(6) Fit the liner retaining nut and screw only 1/2 way down

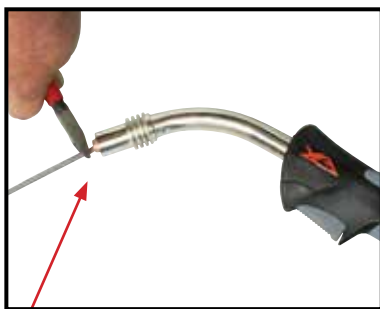

(7) Snip the liner off 3mm past the end of the torch neck.



(8) Replace the front end parts

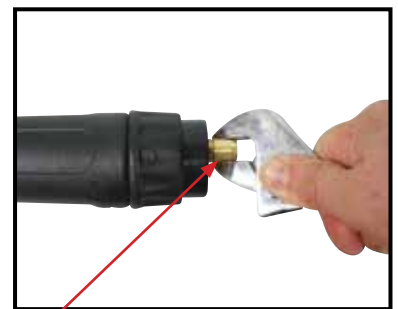

(9) Fully screw down the liner retaining nut and nip it up tight.

## Torch & Wire Feed Set Up for Aluminium Wire

- (1) Lay the torch out straight on the ground and remove the front end parts
- (2) Remove the liner retaining nut.
- (3) Carefully pull the liner out of the torch cable assembly
- (4) Select a PA or liner, carefully and slowly feed the liner in short forward movements down the cable assembly all the way through and out the torch neck end. Avoid kinking the liner, kinking the liner will ruin it and require replacement.
- (5) Leave the liner extending out the end of the torch neck end by 1/8in
- (5) Fit the liner retaining nut together with the liner o-ring.
- 8) Push the liner firmly into the torch lead and tighten the liner retaining nut.
- (9) Install a U groove drive roller of the correct size to match the wire diameter being used.

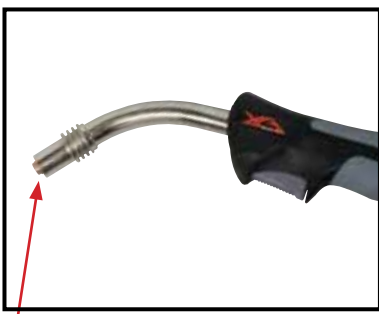

(1) Remove mig torch front end parts

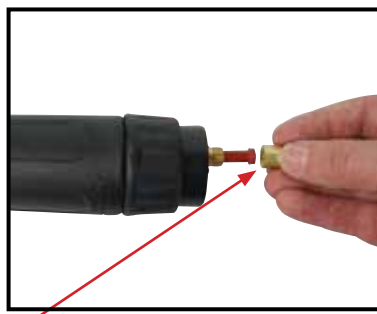

(2) Remove the liner retaining nut

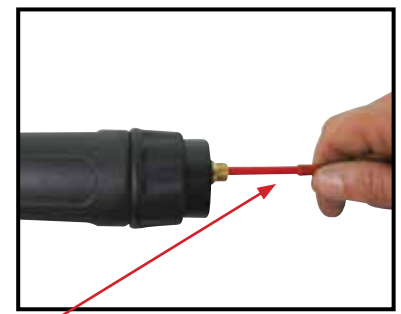

(3) Carefully pull out and completely remove the liner

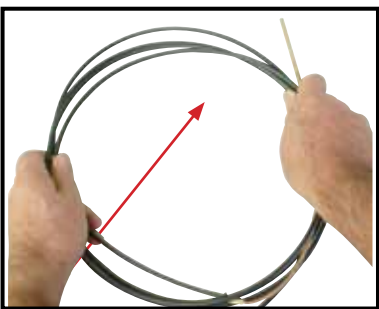

(4) Carefully unravel the new liner

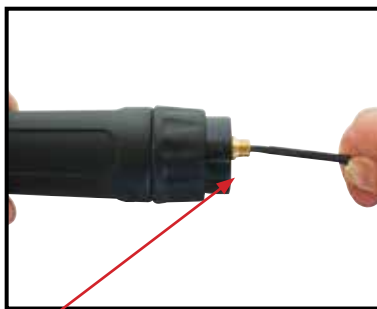

(5) Carefully feed in the new liner in short forward movements down the torch lead all the way to exit the torch neck. Be careful not to kink the liner

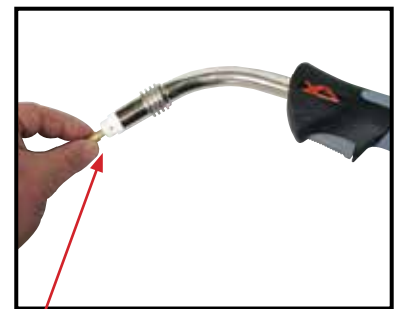

(6) Replace the front end parts

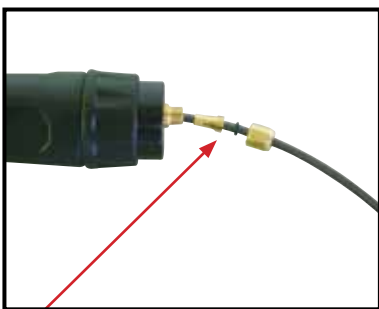

(7) Fit the liner collet, liner O-ring and liner retaining nut.

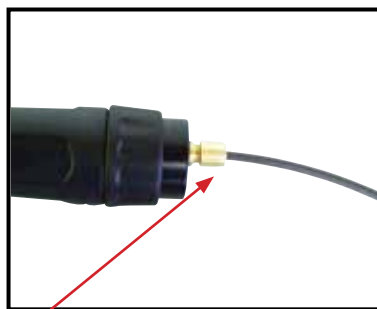

(8) Push the liner firmly into the torch lead and tighten the liner retaining nut



(9) Cut the liner flush with the end of liner retaining nut using a sharp box cutter knife.

## Continued Torch & Wire Feed Set Up for Aluminum Wire

- (10) Loosen off the inlet guide tube retaining screw
- (11) Remove the inlet guide tube from the front end machine euro connector using long nose pliers.
- (12) Carefully feed the extended PA liner section into the inlet guide tube hole of the machine euro connector
- (13) Feed the extended PA liner all the way up and over the drive roller
- (14) Tighten the torch euro connection to the machine euro connector
- (15) Cut the extended liner with a sharp razor knife just in front of the drive roller
- (16) Fit an Aluminum contact tip of the correct size to match the diameter of the wire being used
- (17) Fit the remaining front end parts to the torch neck ready for welding

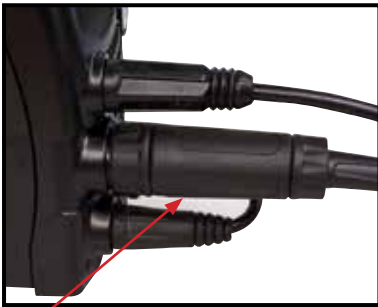

(10) Connect the torch to the machine, tighten and secure the torch euro connector to the machine euro connection.

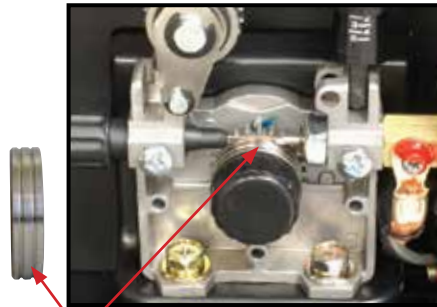

(11) Install a U groove drive roller of the correct size for the diameter wire being used.  
NOTE: MIG 180-145 not geared



(7) Place aluminum wire onto spool holder. Feed the wire through the inlet guide tube on to the drive roller.  
NOTE: MIG 180-145 not geared



(12) Press and hold the inch wire button to feed the wire down the torch cable through to the torch head.

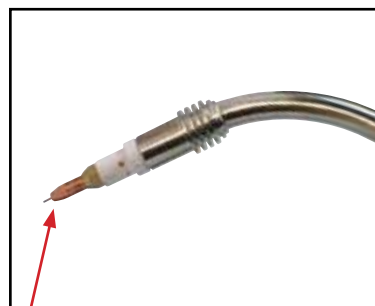

(16) Fit an Aluminium contact tip of the correct size to match the wire diameter being used

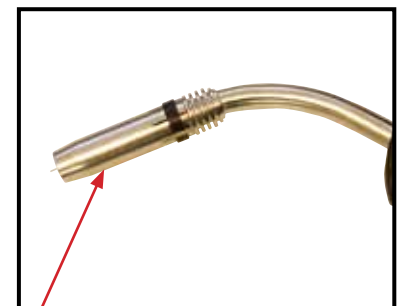

(17) Fit the remaining front end parts to the torch neck ready for welding.

**NOTE:**  
GEAR DRIVE FEEDER ON 210 MODEL ONLY

## Installation set up of the Spool Gun for RAZOR 210

- (1) Select **Spool Gun** using the Standard/Spool Gun selector switch.
- (2) Connect the Spool Gun to the Euro MIG torch connection socket on the front panel, and tighten it. Connect the Spool Gun control cable to the receptacle and tighten it.  
**IMPORTANT** : When connecting the torch be sure to tighten the connection. A loose connection can result in the connector arcing and damaging the machine and gun connector. This damage is not covered under warranty.
- (3) Insert the earth cable plug into the **Negative** socket on the front of the machine and tighten it.
- (4) Connect weld power lead to **Positive** socket
- (5) Connect **Gas Line** to **Gas Regulator** and connect the gas regulator to the **Gas Cylinder**.
- (6) Turn the power source on and select the **MIG** function with the MIG/TIG/MMA selector switch.
- (7) Take the Spool Gun and push the **Cover Release Button** to unlock the wire feed / spool cover.
- (8) Place the **Wire Spool** onto the **Spool Holder** - Note: the spool retaining nut is Left Hand thread. Hold and snip the wire from the spool being sure to hold the wire to prevent rapid uncoiling.



(1) Set Standard/Spoolgun selector switch inside door to Spoolgun

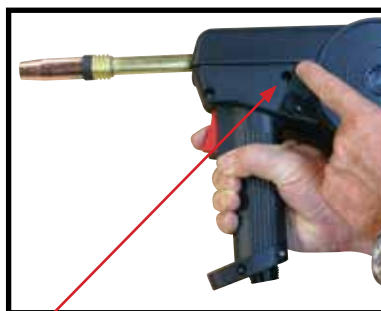

(7) Push the cover release button to unlock the wire feed / spool cover

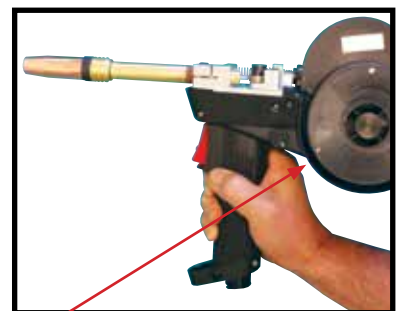

(8) Place a spool of wire onto the Spool holder. Note: the spool retaining nut is Left Hand thread, turn it clockwise to undo it

### **WARNING:**

Ensure that an approved welding helmet, protective clothing and gloves are use for all welding operations

### **WARNING:**

Disconnect the Electrode Holder cable from the machine before using MIG function. If cable is not disconnected welding voltage is present and can cause arcing or flash.

## Continued set up of the Spool Gun with RAZOR 210

- (9) Carefully feed the wire over the drive roller into the outlet guide tube, feed through into the torch neck. Check that the drive roller being used complies with the wire diameter, replace the roller if necessary.
- (10) Align the wire into the groove of the drive roller and release the tension arm making sure the wire is in the groove of the drive roller.
- (11) Apply a adequate amount of pressure to the drive roller by winding in the tension adjusting knob,
- (12) Adjust spool hoder tension
- (13) Remove the gas nozzle and contact tip from the torch neck, Pull the trigger to drive the wire through the neck until it exits the contact tip holder
- (14) Fit the correct sized contact tip and feed the wire through it, screw the contact tip into the tip holder of the torch neck and nip it up tightly.
- (15) Fit the gas nozzle to the torch head and close the wire spool cover.
- (16) Carefully open the gas cylinder valve and set the flow rate to between 21-30cfh.
- (17) Set the welding parameters using the wire feed and voltage control knobs.

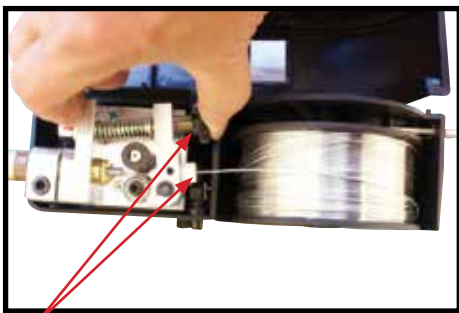

(9) Carefully feed the wire through the inlet guide tube onto the drive roller through into the outlet guide tube. Squeezing the tension arm adjustment knob to release the pressure of the tension arm will allow the wire to be guided through the drive roller easily

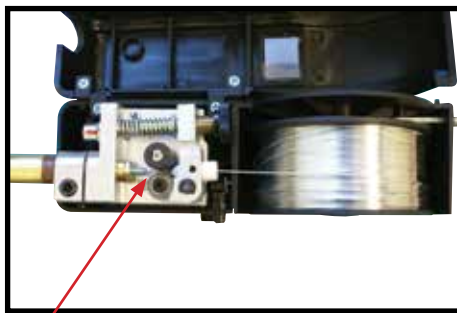

(10) Check to make sure that the wire passes cleanly through the drive roller into the outlet guide tube.

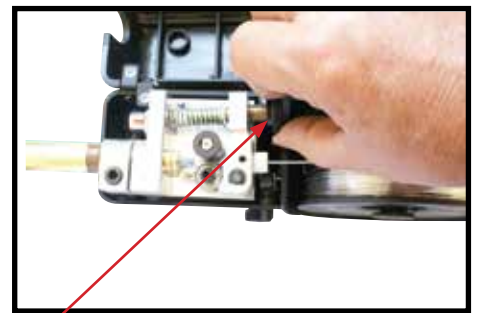

(11) Apply a medium amount of pressure using the tension arm adjustment knob.



(12) Adjust spool holder tension

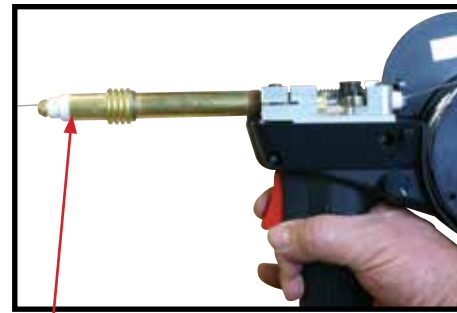

(13) Remove the gas nozzle and contact tip. Pull the trigger to drive the wire through the neck until it exits the contact tip holder

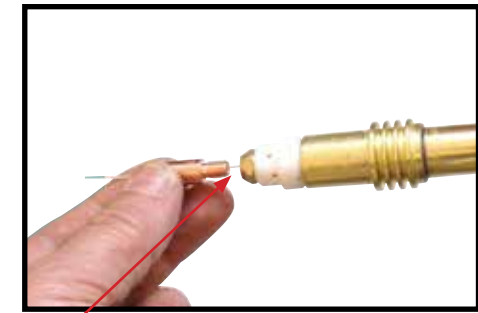

(14) Fit the contact tip over the wire and screw it into the tip holder, nip it up tight.

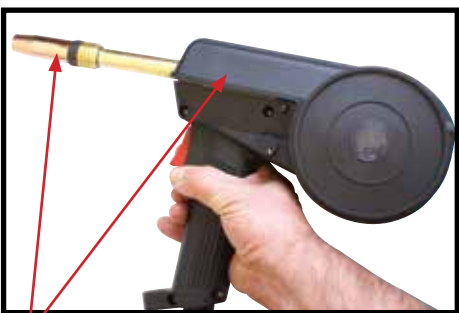

(15) Fit the gas nozzle and close the wire feed spool cover



(16) Carefully open the valve of the gas cylinder, set the flow to 12-15 l/min



(17) Set welding parameters using the voltage and wire feed controls.



## MIG (Metal Inert Gas) Welding

**Definition of MIG Welding** - MIG (metal inert gas) welding also known as GMAW (gas metal arc welding) or MAG (metal active gas welding), is a semi-automatic or automatic arc welding process in which a continuous and consumable wire electrode and a shielding gas are fed through a welding gun. A constant voltage, direct current power source is most commonly used with MIG welding. There are four primary methods of metal transfer in MIG welding, called short circuit (also known as dip transfer) globular transfer, spray transfer and pulsed-spray, each of which has distinct properties and corresponding advantages and limitations. To perform MIG welding, the basic necessary equipment is a welding gun, a wire feed unit, a welding power supply, an electrode wire, and a shielding gas supply. Short circuit transfer is the most common used method whereby the wire electrode is fed continuously down the welding torch through to and exiting the contact tip. The wire touches the work piece and causes a short circuit the wire heats up and begins to form a molten bead, the bead separates from the end of the wire and forms a droplet that is transferred into the weld pool. This process is repeated about 100 times per second, making the arc appear constant to the human eye.

### MIG Circuit Diagram

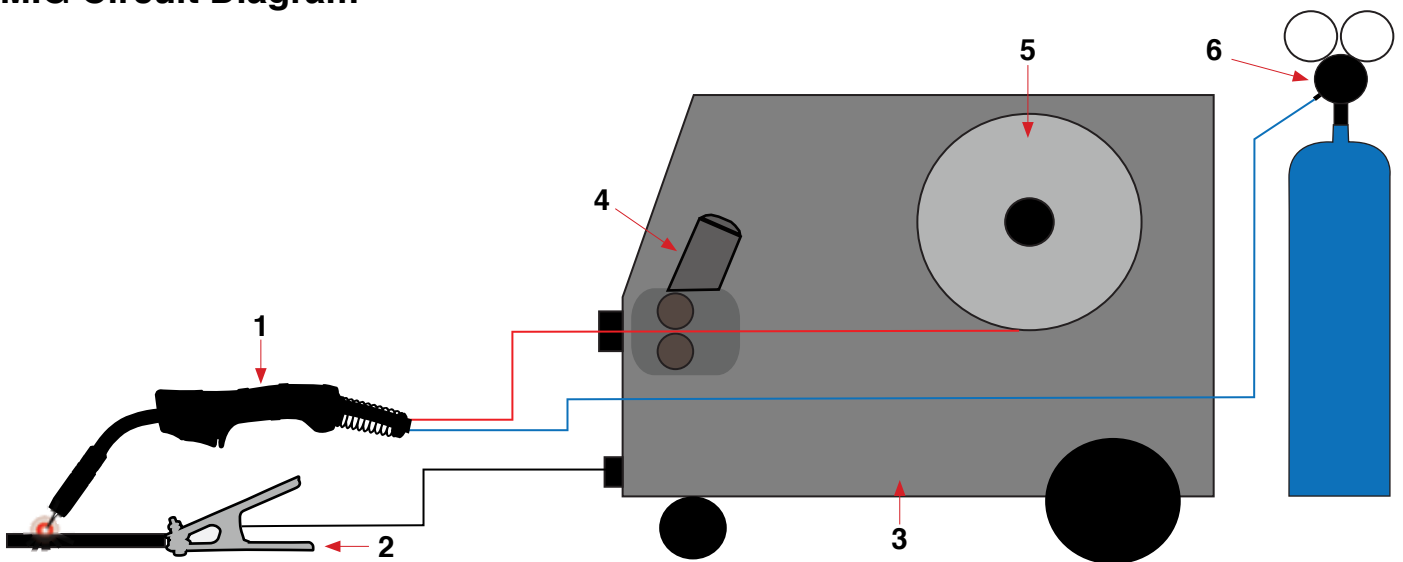

1. Mig Torch - 2. Work Piece - 3. Power Source - 4. Wire Feeder - 5. Wire Spool - 6. Gas

## MIG (Metal Inert Gas) Welding

**Short Circuit Transfer** - Short circuit transfer is the most common used method whereby the wire electrode is fed continuously down the welding torch through to and exiting the contact tip. The wire touches the work piece and causes a short circuit the wire heats up and begins to form a molten bead, the bead separates from the end of the wire and forms a droplet that is transferred into the weld pool. This process is repeated about 100 times per second, making the arc appear constant to the human eye.

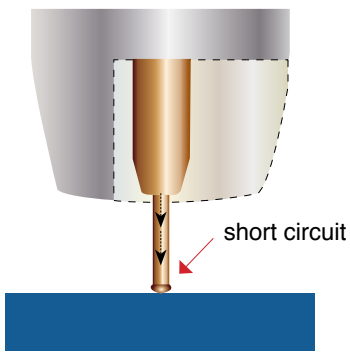

The wire approaches the work piece and touches the work creating a short circuit between the wire and the base metal, because there is no space between the wire and the base metal there is no arc and current flows through the wire.

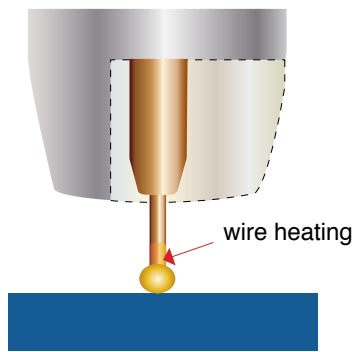

The wire cannot support all the current flow, resistance builds up and the wire becomes hot and weak and begins to melt

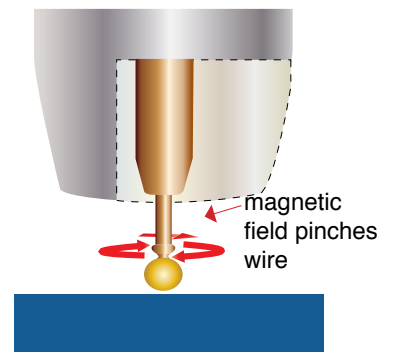

The current flow creates a magnetic field that begins to pinch the melting wire forming it into droplet

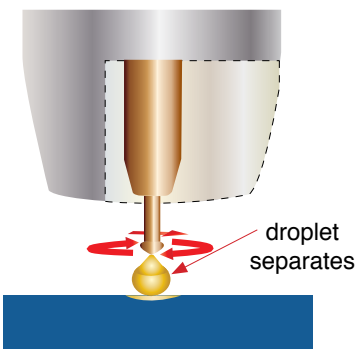

The pinch causes the forming droplet to separate and fall towards the now creating weld pool.

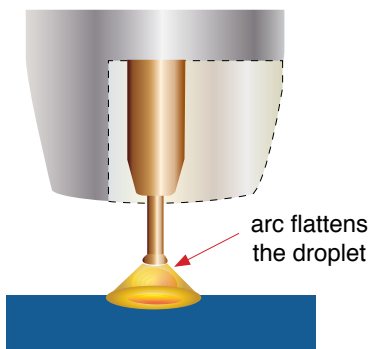

An arc is created at the separation of the droplet and the heat and force of the arc flattens out the droplet into the weld pool. The heat of the arc melts the end of the wire slightly as it feeds towards the base metal

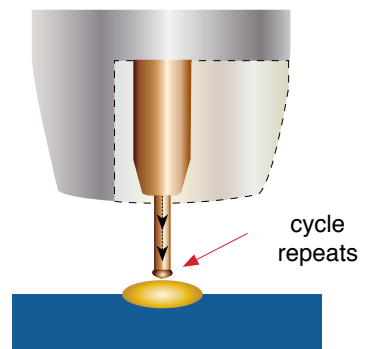

The wire feed speed overcomes the heat of the arc and the wire again approaches the work to short circuit and repeat the cycle.

## Basic MIG Welding .

Good weld quality and weld profile depends on gun angle, direction of travel, electrode extension (stick out), travel speed, thickness of base metal, wire feed speed (amperage) and arc voltage. To follow are some basic guides to assist with your setup.

### Gun Position - Travel Direction, Work Angle

Gun position or technique usually refers to how the wire is directed at the base metal, the angle and travel direction chosen. Travel speed and work angle will determine the characteristic of the weld bead profile and degree of weld penetration.

**Push Technique** - The wire is located at the leading edge of the weld pool and pushed towards the un-melted work surface. This technique offers a better view of the weld joint and direction of the wire into the weld joint. Push technique directs the heat away from the weld puddle allowing faster travel speeds providing a flatter weld profile with light penetration - useful for welding thin materials. The welds are wider and flatter allowing for minimal clean up / grinding time.

**Perpendicular Technique** - The wire is fed directly into the weld, this technique is used primarily for automated situations or when conditions make it necessary. The weld profile is generally higher and a deeper penetration is achieved.

**Drag Technique** - The gun and wire is dragged away from the weld bead. The arc and heat is concentrated on the weld pool, the base metal receives more heat, deeper melting, more penetration and the weld profile is higher with more build up.

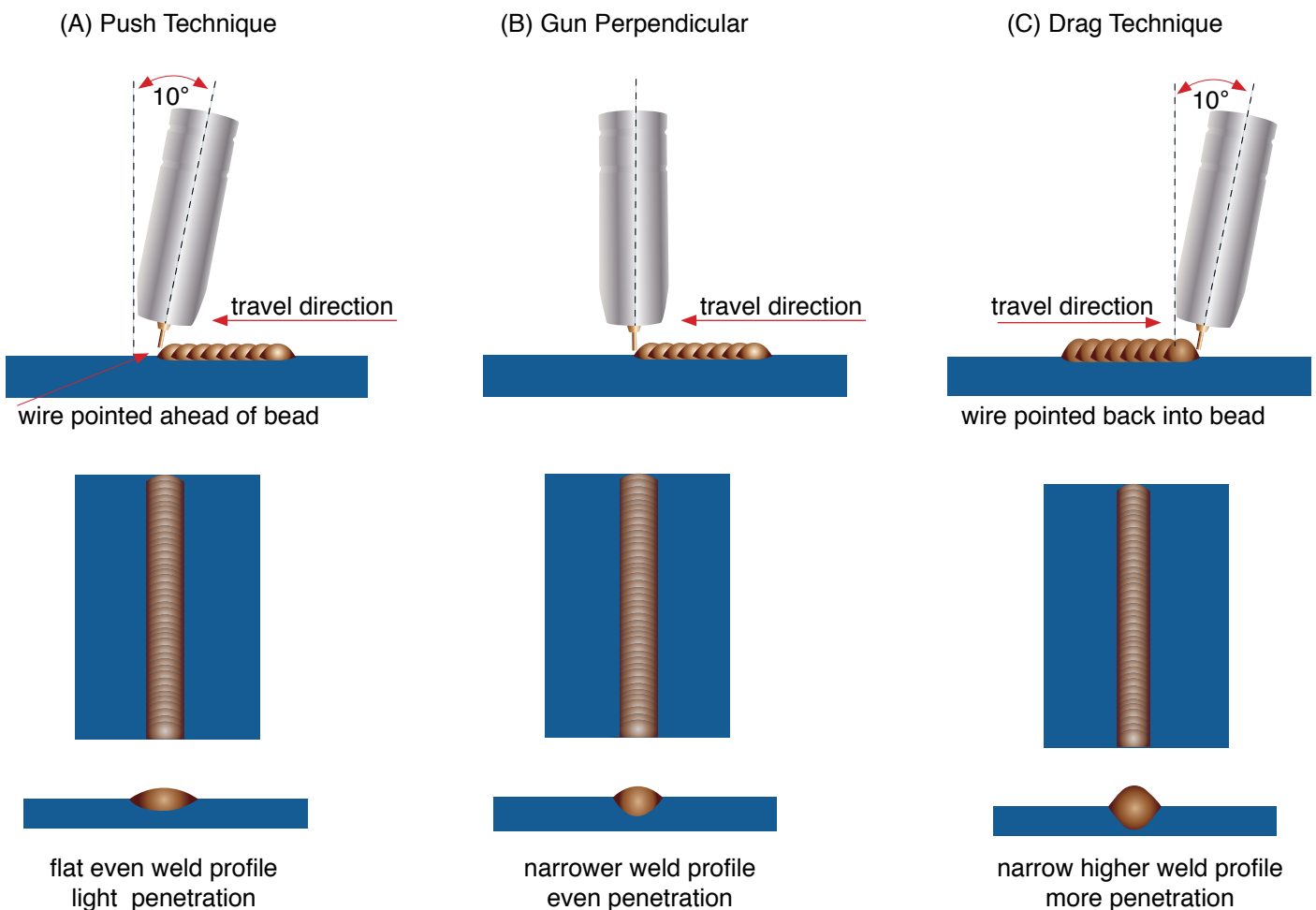

**Travel Angle** - Travel angle is the right to left angle relative to the direction of welding. A travel angle of 5° - 15° is ideal and produces a good level of control over the weld pool. A travel angle greater than 20° will give an unstable arc condition with poor weld metal transfer, less penetration, high levels of spatter, poor gas shield and poor quality finished weld.

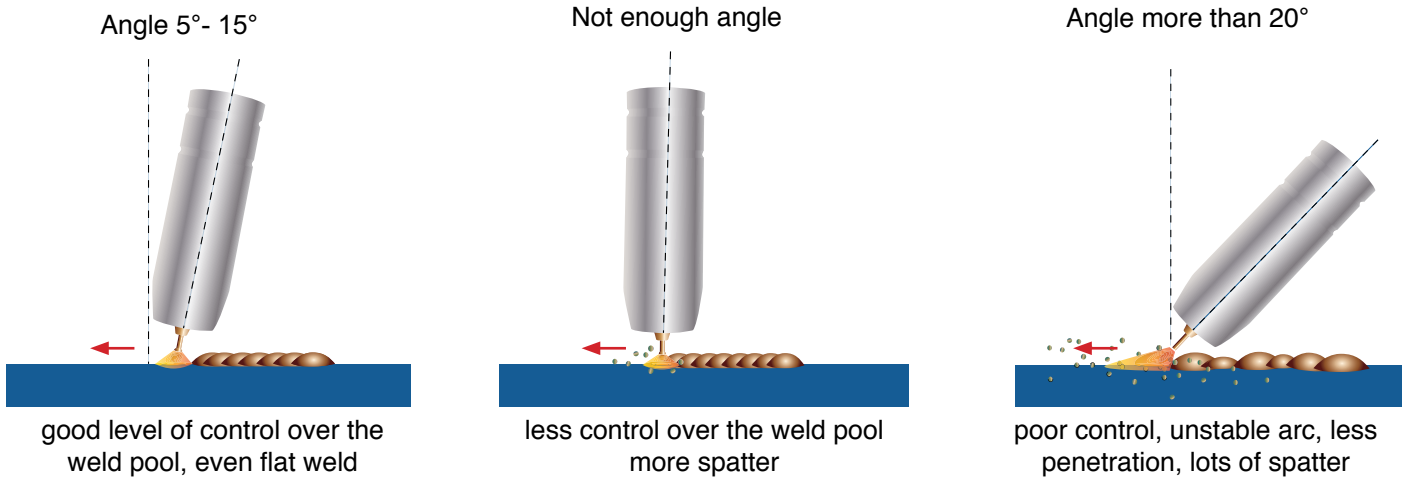

**Angle to Work** - The work angle is the forward back angle of the gun relative to the work piece. The correct work angle provides good bead shape, prevents undercut, uneven penetration, poor gas shield and poor quality finished weld.

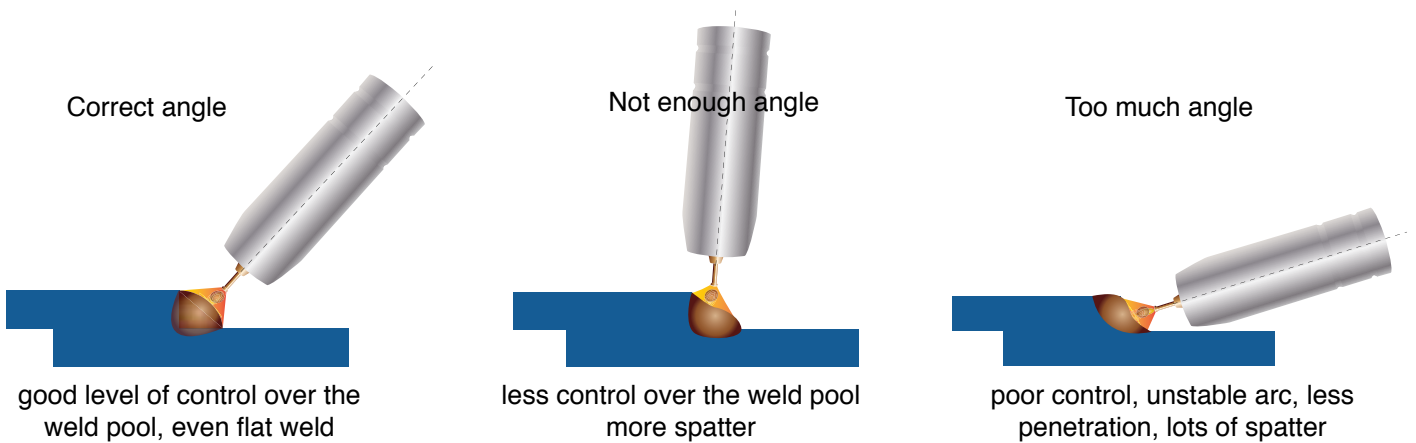

**Stick Out**- Stick out is the length of the unmelted wire protruding from the end of the contact tip. A constant even stick out of 1/8-1/4" will produce a stable arc, and an even current flow providing good penetration and even fusion. Too short stick out will cause an unstable weld pool, produce spatter and over heat the contact tip. Too long stick out will cause an unstable arc, lack of penetration, lack of fusion and increase spatter.

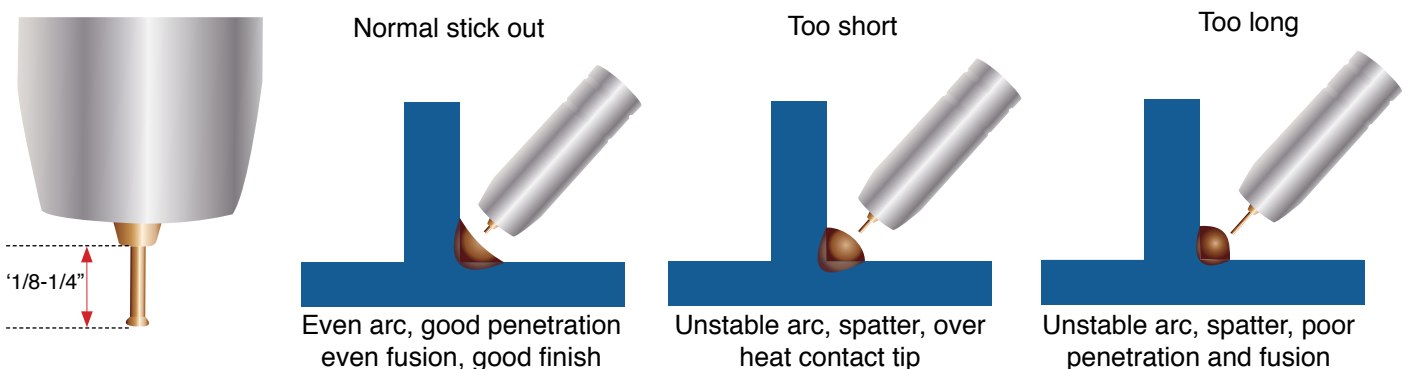

**Travel Speed** - Travel speed is the rate that the gun is moved along the weld joint and is usually measured in mm per minute. Travel speeds can vary depending on conditions and the welders skill and is limited to the welders ability to control the weld pool. Push technique allows faster travel speeds than Drag technique. Gas flow must also correspond with the travel speed, increasing with faster travel speed and decreasing with slower speed. Travel speed needs to match the amperage and will decrease as the material thickness and amperage increase.

**Too Fast Travel Speed** - A too fast travel speed produces too little heat per inch of travel resulting in less penetration and reduced weld fusion, the weld bead solidifies very quickly trapping gases inside the weld metal causing porosity. Undercutting of the base metal can also occur and an unfilled groove in the base metal is created when the travel speed is too fast to allow molten metal to flow into the weld crater created by the arc heat.

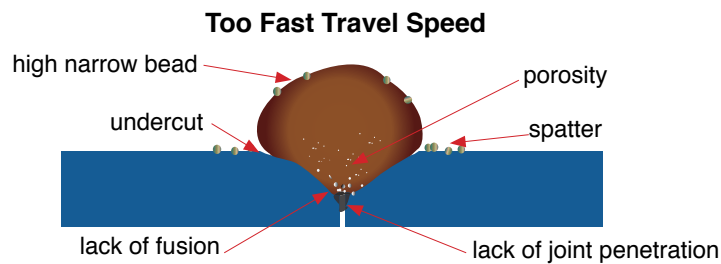

**Too Slow Travel Speed** - A too slow travel speed produces a large weld with lack of penetration and fusion. The energy from the arc dwells on top of the weld pool rather than penetrating the base metal. This produces a wider weld bead with more deposited weld metal per mm than is required resulting in a weld deposit of poor quality.

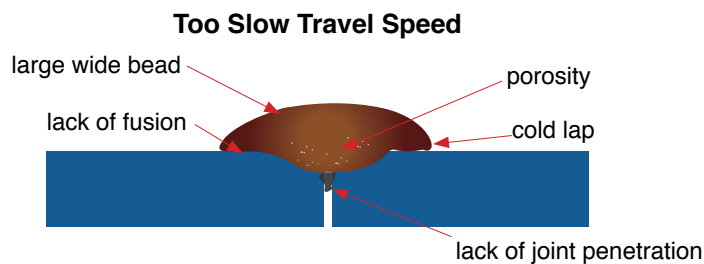

**Correct Travel Speed** - The correct travel speed keeps the arc at the leading edge of the weld pool allowing the base metal to melt sufficiently to create good penetration, fusion and wetting out of the weld pool producing a weld deposit of good quality.

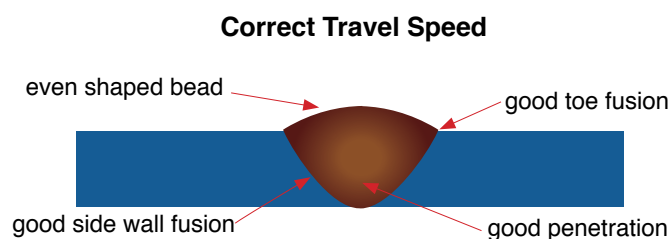

**Wire types and sizes** - Use the correct wire type for the base metal being welded. Use stainless steel wire for stainless steel, aluminium wires for aluminium and steel wires for steel.

Use a smaller diameter wire for thin base metals. For thicker materials use a larger wire diameter and larger machine, check the recommended welding capability of you machine.

As a guide refer to the “Welding Wire Thickness Chart” below.

WELDING WIRE DIAMETER CHART							
MATERIAL THICKNESS	RECOMMENDED WIRE DIAMETERS						
	MIG SOLID WIRE				GASLESS FLUX CORED WIRE		
	0.025"	0.030"	0.035"	0.040"	0.030"	0.035"	0.045"
24 Gauge (.60mm)	Yellow						
22 Gauge (.75mm)	Yellow	Yellow			Yellow		
20 Gauge (.90mm)	Yellow	Yellow			Yellow	Yellow	
18 Gauge (1.0mm)	Yellow	Yellow	Yellow		Yellow	Yellow	
16 Gauge (1.2mm)		Yellow	Yellow		Yellow	Yellow	Yellow
14 Gauge (1.9mm)		Yellow	Yellow	Yellow	Yellow	Yellow	Yellow
0.118" / 3.0mm		Yellow	Yellow	Yellow		Yellow	
0.196" / 5.0mm			Yellow	Yellow		Yellow	
0.236" / 6.0mm			Yellow	Yellow			Yellow
0.314" / 8.0mm			Yellow	Yellow			Yellow
0.393" / 10.0mm				Yellow			Yellow
0.472" / 12.0mm				Yellow			

For material thickness of 0.196" / 5.0mm and greater, multi-pass runs or a beveled joint design may be required depending on the amperage capability of your machine.

**Gas selection** - The purpose of the gas in the MIG process is to protect / shield the wire, the arc and the molten weld metal from the atmosphere. Most metals when heated to a molten state will react with the air in the atmosphere, without the protection of the shielding gas the weld produced would contain defects like porosity, lack of fusion and slag inclusions. Additionally some of the gas becomes ionised (electrically charged) and helps the current flow smoothly.

The correct gas flow is also very important in protecting the welding zone from the atmosphere. Too low flow will give inadequate coverage and result in weld defects and unstable arc conditions. Too high flow can cause air to be drawn into the gas column and contaminate the weld zone.

Use the correct shielding gas. Co2 is good for steel and offers good penetration characteristics, the weld profile is narrower and slightly more raised than the weld profile obtained from Argon Co2 mixed gas. Argon Co2 mix gas offers better weld ability for thin metals and has a wider range of setting tolerance on the machine. Argon 75% Co2 25% is a good all round mix suitable for most applications.

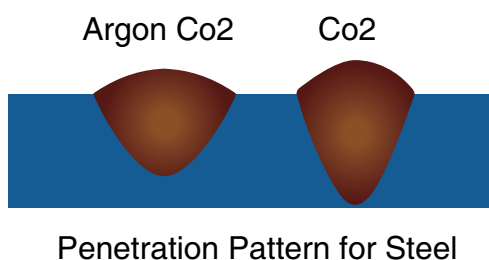

## Installation and set up for DC TIG welding for RAZOR 210

- (1) Connect TIG torch to **Euro** connection socket,  
IMPORTANT : When connecting the torch be sure to tighten the connection.
  - (2) Connect earth lead to **Positive**
  - (3) Connect weld power lead to **Negative**
  - (4) Turn the power source on and select the **TIG** function with the MIG/TIG/MMA selector switch.
  - (5) Set torch operation 2T / 4T.
    - When 2T operation is selected press trigger Gas starts, touch and lift arc start, release trigger Gas and Arc stops.
    - When 2T operation is selected with downslope time of either 1 to 10 seconds press trigger Gas starts, touch and lift arc star, release trigger, after 1 to 10 seconds depending on the downslope time selected Gas and Arc stops. Crater fill operation is automatic to factory preset level.
    - When 4T operation is selected press and release trigger Gas starts, touch and lift arc start, press and release trigger Gas and Arc stops.
    - When 4T operation is selected with downslope time of either 1 to 10 seconds press and release trigger Gas starts, touch and lift arc start Press and hold trigger, after 1 to 10 seconds depending on the downslope time selected Arc crater fill downslopes, crater fill operation is automatic to factory preset level., release trigger Gas and Arc stops
- NOTE: This feature is recommend for welding above 70Amps only.**
- (6) Connect the gas line to regulator and connect the regulator to the gas cylinder.



### **WARNING:**

Ensure that an approved welding helmet, protective clothing and gloves are use for all welding operations

### **WARNING:**

Disconnect the Electrode Holder cable from the machine before using MIG function. If cable is not disconnected welding voltage is present and can cause arcing or flash.

## LIFT ARC DC TIG Operation for RAZOR 210

Lift Arc ignition allows the arc to be started easily in DC TIG by simply touching the tungsten to the work piece and lifting it up to start the arc. This prevents the tungsten tip sticking to the work piece and breaking the tip from the tungsten electrode. There is a particular technique called “rocking the cup” used in the Lift Arc process that provides easy use of the Lift Arc function.

- (7) Carefully open the valve of the gas cylinder, set the flow to 21-30cfh
- (8) Set the welding current using the amperage control dial
- (9) Make sure the front end parts of the tig torch are correctly assembled, use the correct size and type of tungsten electrode for the job, the tungsten electrode requires a sharpened point for DC welding.
- (10) Lay the outside edge of the Gas Cup on the work piece with the Tungsten Electrode 1/16 inm from the work piece. Press the trigger button on TIG torch to start the gas flow.
- (11) With a small movement rotate the Gas Cup forward so that the Tungsten Electrode touches the work piece.
- (12) Now rotate the Gas Cup in the reverse direction to lift the Tungsten electrode from the work piece to create the arc.



(7) Carefully open the valve of the gas cylinder, set the flow to 6-10 l/min



(8) Set the welding current using the amperage control dial

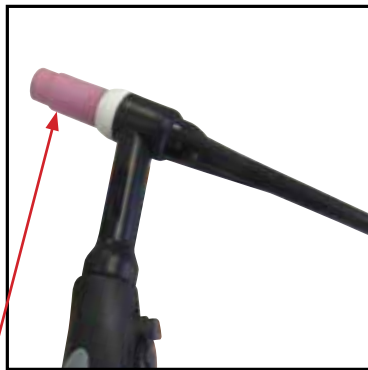

(9) Assemble front end parts of the TIG torch, fitting a sharpened tungsten suitable for DC welding.

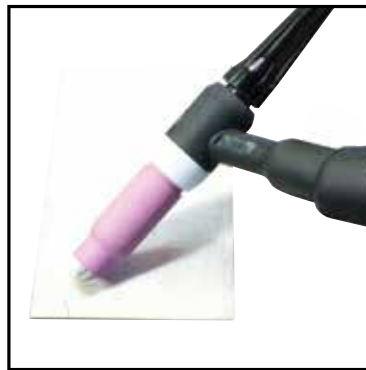

(10) Lay the outside edge of the Gas Cup on the work piece with the Tungsten Electrode 1/16in from the work piece. Press the trigger button on TIG torch to start the gas flow.



(11) With a small movement rotate the Gas Cup forward so that the Tungsten Electrode touches the work piece.

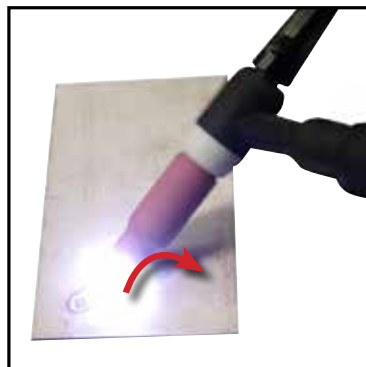

(12) Now rotate the Gas Cup in the reverse direction to lift the Tungsten electrode from the work piece to create the arc.



## TIG Welding Fusion Technique

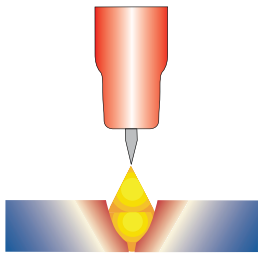

Manual TIG welding is often considered the most difficult of all the welding processes. Because the welder must maintain a short arc length, great care and skill are required to prevent contact between the electrode and the workpiece. Similar to Oxygen Acetylene torch welding, Tig welding normally requires two hands and in most instances requires the welder to manually feed a filler wire into the weld pool with one hand while manipulating the welding torch in the other. However, some welds combining thin materials can be accomplished without filler metal like edge, corner, and butt joints.

This is known as Fusion welding where the edges of the metal pieces are melted together using only the heat and arc force generated by the TIG arc. Once the arc is started the torch tungsten is held in place until a weld pool is created, a circular movement of the tungsten will assist in creating a weld pool of the desired size. Once the weld pool is established tilt the torch at about a 75° angle and move smoothly and evenly along the joint while fusing the materials together.

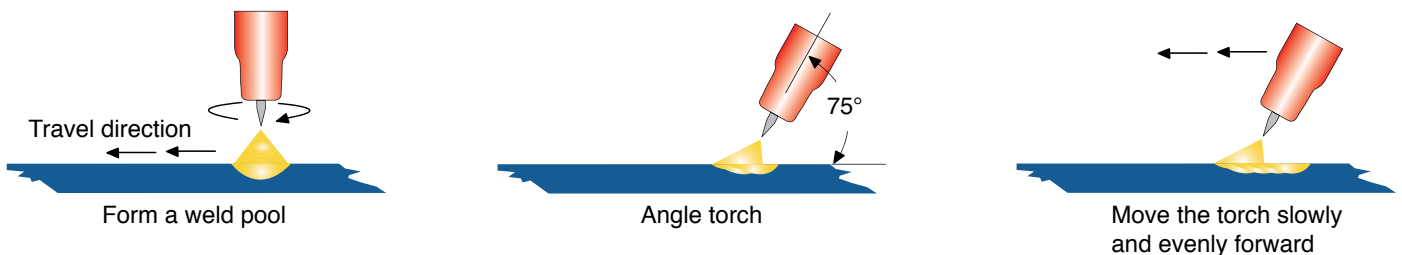

## TIG Welding with Filler Wire Technique

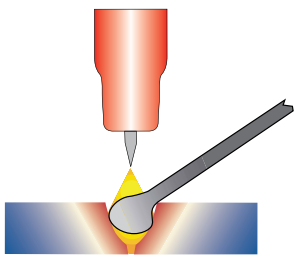

It is necessary in many situations with TIG welding to add a filler wire into the weld pool to build up weld reinforcement and create a strong weld. Once the arc is started the torch tungsten is held in place until a weld pool is created, a circular movement of the tungsten will assist in creating a weld pool of the desired size. Once the weld pool is established tilt the torch at about a 75° angle and move smoothly and evenly along the joint. The filler metal is introduced to the leading edge of the weld pool. The filler wire is usually held at about a 15° angle and fed into the leading edge of the molten pool, the arc will melt the filler wire into the weld pool as the torch is moved forward.

Also a dabbing technique can be used to control the amount of filler wire added, the wire is fed into the molten pool and retracted in a repeating sequence as the torch is moved slowly and evenly forward. It is important during the welding to keep the molten end of the filler wire inside the gas shield as this protects the end of the wire from being oxidized and contaminating the weld pool.

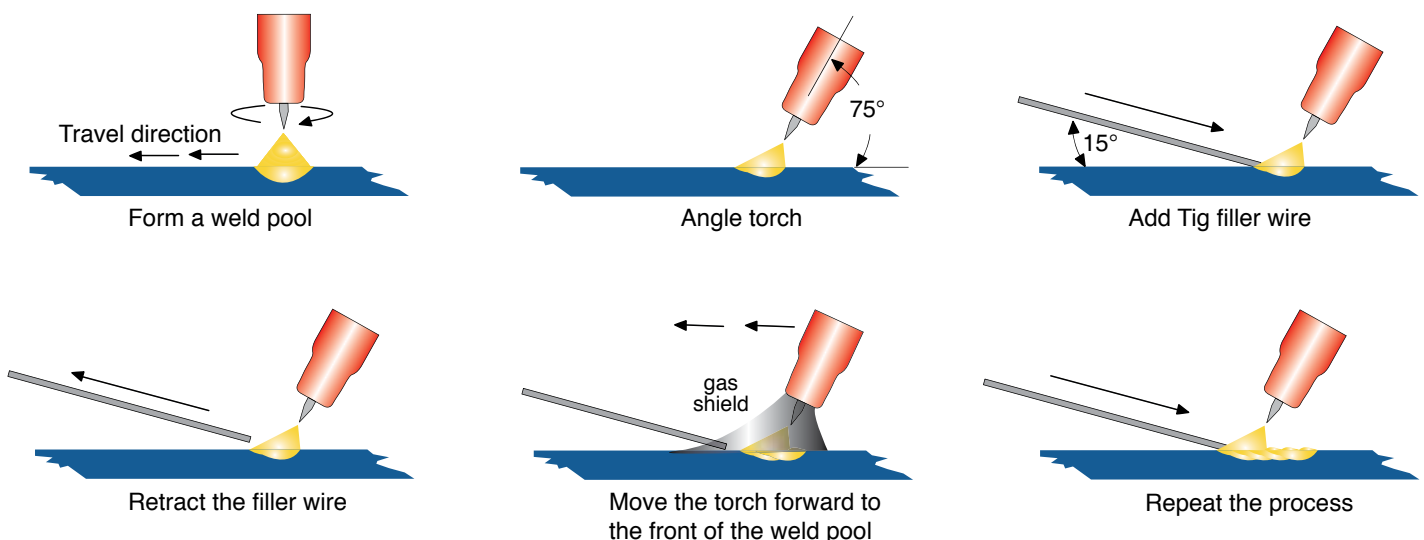

# Tungsten Electrodes

Tungsten is a rare metallic element used for manufacturing TIG welding electrodes. The TIG process relies on tungsten's hardness and high-temperature resistance to carry the welding current to the arc. Tungsten has the highest melting point of any metal, 3,410 degrees Celsius.

Tungsten electrodes are nonconsumable and come in a variety of sizes, they are made from pure tungsten or an alloy of tungsten and other rare earth elements. Choosing the correct tungsten depends on the material being welded, the amount of amps required and whether you are using AC or DC welding current.

Tungsten electrodes are colour-coded at the end for easy identification.

Below are the most commonly used tungsten electrodes found in the New Zealand and Australian market.

## Thoriated

Thoriated tungsten electrodes (AWS classification EWTh-2) contain a minimum of 97.30 percent tungsten and 1.70 to 2.20 percent thorium and are called 2 percent thoriated. They are the most commonly used electrodes today and are preferred for their longevity and ease of use. Thorium increases the electron emission qualities of the electrode, which improves arc starts and allows for a higher current-carrying capacity. This electrode operates far below its melting temperature, which results in a considerably lower rate of consumption and eliminates arc wandering for greater stability. Compared with other electrodes, thoriated electrodes deposit less tungsten into the weld puddle, so they cause less weld contamination.

Thorium however is a low-level radioactive hazard and many users have switched to other alternatives. Regarding the radioactivity, thorium is an alpha emitter but when it is enclosed in a tungsten matrix the risks are negligible. Thus holding a stick of Thoriated tungsten in your hand should not pose a great threat unless a welder has open cuts on their skin. Thoriated tungsten should not get in contact with open cuts or wounds. The more significant danger to welders can occur when thorium oxide gets into the lungs. This can happen from the exposure to vapours during welding or from ingestion of material/dust in the grinding of the tungsten. Follow the manufacturer's warnings, instructions, and the Material Safety Data Sheet (MSDS) for its use.

## Ceriated (Color Code: Orange)

Ceriated tungsten electrodes (AWS classification EWCe-2) contain a minimum of 97.30 percent tungsten and 1.80 to 2.20 percent cerium and are referred to as 2 percent ceriated. Ceriated tungstens perform best in DC welding at low current settings. They have excellent arc starts at low amperages and become popular in such applications as orbital tube welding, thin sheet metal work. They are best used to weld carbon steel, stainless steel, nickel alloys, and titanium, and in some cases it can replace 2 percent thoriated electrodes. Ceriated tungsten is best suited for lower amperages it should last longer than Thoriated tungsten higher amperage applications are best left to Thoriated or Lanthanated tungsten.

## Lanthanated (Color Code: Gold)

Lanthanated tungsten electrodes (AWS classification EWL a-1.5) contain a minimum of 97.80 percent tungsten and 1.30 percent to 1.70 percent lanthanum, and are known as 1.5 percent lanthanated. These electrodes have excellent arc starting, a low burn off rate, good arc stability, and excellent re-ignition characteristics. Lanthanated tungstens also share the conductivity characteristics of 2 percent thoriated tungsten. Lanthanated tungsten electrodes are ideal if you want to optimise your welding capabilities. They work well on AC or DC electrode negative with a pointed end, or they can be balled for use with AC sine wave power sources. Lanthanated tungsten maintains a sharpened point well, which is an advantage for welding steel and stainless steel on DC or AC from square wave power sources.

## Zirconiated (Color Code: White)

Zirconiated tungsten electrodes (AWS classification EWZr-1) contain a minimum of 99.10 percent tungsten and 0.15 to 0.40 percent zirconium. Most commonly used for AC welding Zirconiated tungsten produces a very stable arc and is resistant to tungsten spitting. It is ideal for AC welding because it retains a balled tip and has a high resistance to contamination. Its current-carrying capacity is equal to or greater than that of thoriated tungsten. Zirconiated tungsten is not recommended for DC welding.

## Tungsten Electrodes Rating for Welding Currents

Tungsten Diameter mm	DC Current Amps Torch Negative 2% Thoriated	AC Current Amps Un-Balanced Wave 0.8% Zirconiated	AC Current Amps Balanced Wave 0.8% Zirconiated
3/64" (.040")	15 - 80	15 - 80	20 - 60
1/16" (.062" & .060")	70 - 150	70 - 150	60 - 120
3/32" (.93")	150 - 250	140 - 235	100 - 180
1/8" (.125")	250 - 400	225 - 325	160 - 250
5/32" (.156")	400 - 500	300 - 400	200 - 320

# Tungsten Preparation

Always use **DIAMOND** wheels when grinding and cutting. While tungsten is a very hard material, the surface of a diamond wheel is harder, and this makes for smooth grinding. Grinding without diamond wheels, such as aluminium oxide wheels, can lead to jagged edges, imperfections, or poor surface finishes not visible to the eye that will contribute to weld inconsistency and weld defects.

Always ensure to grind the tungsten in a longitudinal direction on the grinding wheel. Tungsten electrodes are manufactured with the molecular structure of the grain running lengthwise and thus grinding crosswise is “grinding against the grain.” If electrodes are ground crosswise, the electrons have to jump across the grinding marks and the arc can start before the tip and wander. Grinding longitudinally with the grain, the electrons flow steadily and easily to the end of the tungsten tip. The arc starts straight and remains narrow, concentrated, and stable.



## Electrode Tip/Flat

The shape of the tungsten electrode tip is an important process variable in precision arc welding. A good selection of tip/flat size will balance the need for several advantages. The bigger the flat, the more likely arc wander will occur and the more difficult it will be to arc start. However, increasing the flat to the maximum level that still allows arc start and eliminates arc wander will improve the weld penetration and increase the electrode life. Some welders still grind electrodes to a sharp point, which makes arc starting easier. However, they risk decreased welding performance from melting at the tip and the possibility of the point falling off into the weld pool.



## Electrode Included Angle/Taper - DC Welding

Tungsten electrodes for DC welding should be ground longitudinally and concentrically with diamond wheels to a specific included angle in conjunction with the tip/flat preparation. Different angles produce different arc shapes and offer different weld penetration capabilities. In general, blunter electrodes that have a larger included angle provide the following benefits:

- Last Longer
- Have better weld penetration
- Have a narrower arc shape
- Can handle more amperage without eroding.

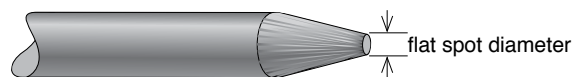

Sharper electrodes with smaller included angle provide:

- Offer less arc weld
- Have a wider arc
- Have a more consistent arc



The included angle determines weld bead shape and size. Generally, as the included angle increases, penetration increases and bead width decreases.

Tungsten Diameter	Diameter at the Tip - mm	Constant Included Angle - Degrees	Current Range Amps	Current Range Pulsed Amps
3/64" (.040")	.250	20	05 - 30	05 - 60
1/16" (.062" & .060")	.500	25	08 - 50	05 - 100
1/16" (.062" & .060")	.800	30	10 - 70	10 - 140
3/32" (.93")	.800	35	12 - 90	12 - 180
3/32" (.93")	1.100	45	15 - 150	15 - 250
1/8" (.125")	1.100	60	20 - 200	20 - 300
1/8" (.125")	1.500	90	25 - 250	25 - 350

## TWC2 Air Cooled Mig Welding Torch

Rating: 200A CO2 150A mixed gas, EN60974-7 @ 60% duty cycle.  
0.6 to 1.2mm / 0.025" to 0.045" 47/34" wires

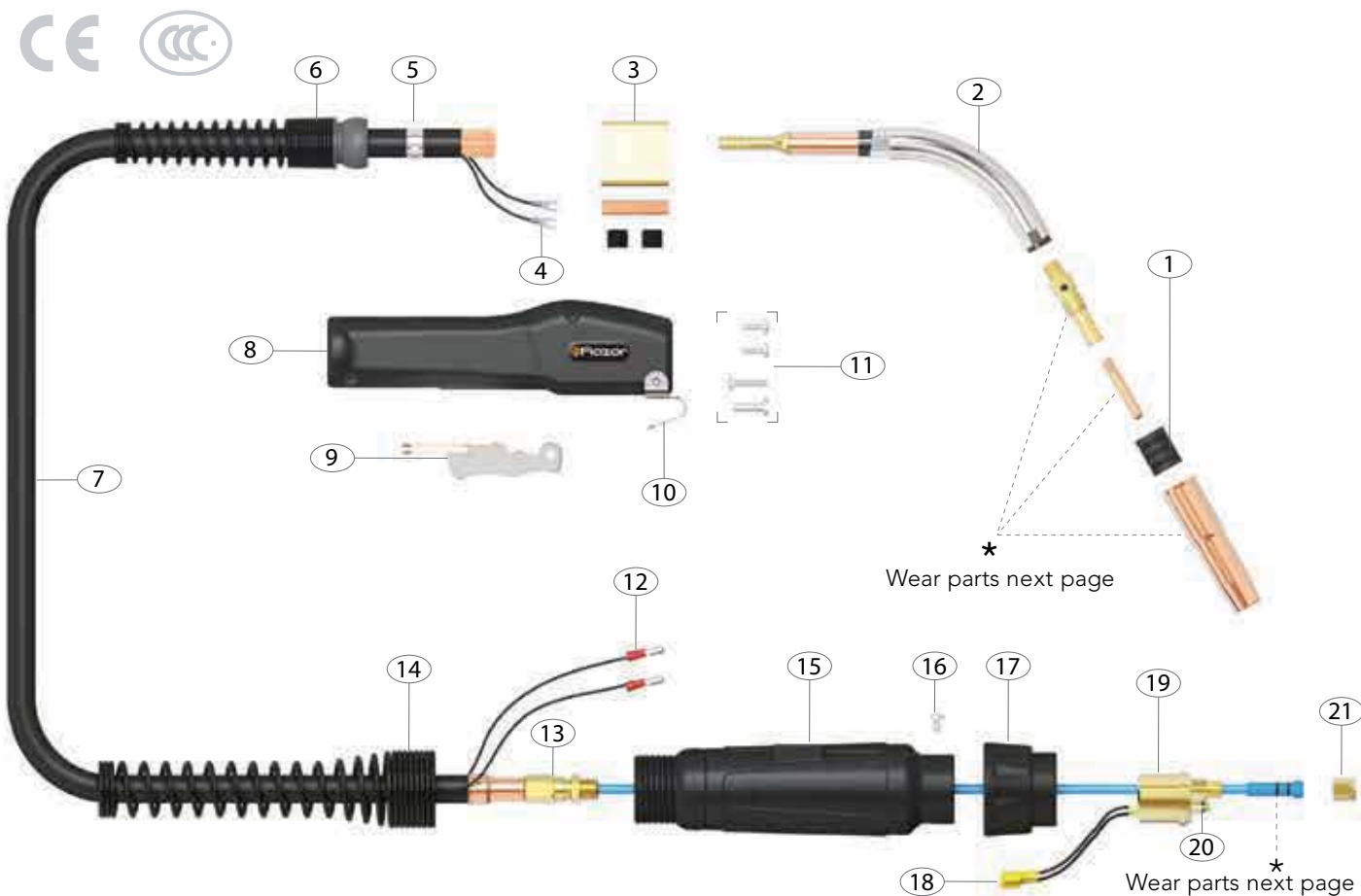

Torch Model	
Description	Part Number
Welding Torch c/w Euro Fitting	TWC2-15FTE

Spare Parts					
Part Number	Description	Part Number	Description	Part Number	Description
1	PWGA32	Adjustable Nozzle Insulator	9	U92	Grey Trigger Switch
2	U62J60	TW No.2 Metal Jacket Neck Assembly	10	U152	Hanger Hook
	WGA62A-45	45 Degree Neck Assembly	11	U122FMS	Screw Kit
	WGA62A-60	60 Degree Neck Assembly	112	UB1522	Cable Terminal Male
3	U102	Block C/W Spacer & Screws	13	UXL1542	Cable End Lock Nut (M12 X 1.0)
4	U244T	Control Wire Terminals	14	UPA2041	Cable Support
5	UB5044	Hose Clamp 18.5mm	15	UB1518	Gun Plug Housing C/W Nut
6	U141-6S	Spring Cable Support Small & Ball Joint	16	UB1526	Gun Plug Screw
7	U200-10E	Hyperflex C/Assy X 10ft Euro	17	UB1519/S	Gun Plug Nut
	U200-12E	Hyperflex C/Assy X 12ft Euro	18	UB1523	Gun Plug Terminal Female
	U200-15E	Hyperflex C/Assy X 15ft Euro	19	U174EX-1	TWC Euro Gun Plug Body
	U200-10	Hyperflex C/Assy X 10ft	20	UB1524	Gun Plug 'O' Ring
	U200-12	Hyperflex C/Assy X 12ft	21	UXL1826	Liner Retaining Nut
	U200-15	Hyperflex C/Assy X 15ft			
8	UP83	Handle With Hook & Screw			

These parts are manufactured in China and are offered as replacement parts suitable for "TWECO" style torches.

# Spare Parts for Tweco 2 style torches



## Torch Model

Description	Part Number	EAN CODE
15 FT Welding Torch Classic Style	TWC2-15FTE	0680474943777
10 FT Welding Torch Euro Style Handle	TWC2-10FTE	0680474944095

## TWC2 Contact Tips

Part Number	Description	QTY	EAN CODE
PRW14-30	Contact tip 0.8mm / 0.030"	QTY x5	0680474943920
PRW14-35	Contact tip 0.9mm / 0.035"	QTY x5	0680474943937
PRW14-40	Contact tip 1.0mm / 0.040"	QTY x5	0680474944033
PRW14-45	Contact tip 1.2mm / 0.045"	QTY x5	0680474944040

## TWC2 Contact Tips H/D

Part Number	Description	QTY	EAN CODE
PRW14H-30	Contact H/D tip 0.8mm / 0.030"	QTY x5	0680474944057
PRW14H-35	Contact H/D tip 0.9mm / 0.035"	QTY x5	0680474944064
PRW14H-40	Contact H/D tip 1.0mm / 0.040"	QTY x5	0680474944071
PRW14H-45	Contact H/D tip 1.2mm / 0.045"	QTY x5	0680474944088

## TWC2 Gas Diffuser

Part Number	Description	QTY	EAN CODE
PRW52	Gas Diffuser	QTY x 2	0680474943975

## TWC2 Gas Insulator

Part Number	Description	QTY	EAN CODE
PRW32	Insulator	QTY x 2	0680474943999

## TWC2 Torch Nozzle

Part Number	Description	QTY	EAN CODE
PRW22-50	Nozzle Adjustable 13mm / (33/67)	QTY x2	0680474943951
PRW22-62	Nozzle Adjustable 16mm / (5/8)	QTY x2	0680474943968

## TWC2 Liners

Part Number	Description	QTY	EAN CODE
PRW42-3035-15	Liner 15 ft 0.8 - 0.9mm / 0.030" - 0.035"	QTY x1	0680474944002
PRW42-4045-15	Liner 15ft 1.0 - 1.2mm / 0.040" - 0.0457"	QTY x1	0680474944101
PRW42N-3035-15	Liner 15ft 0.8- 0.9mm / 0.030" - 0.035" Alloy	QTYx 1	0680474944118



# SPG200II AMP SPOOL GUN

Duty Cycle 35% @ 200Amp

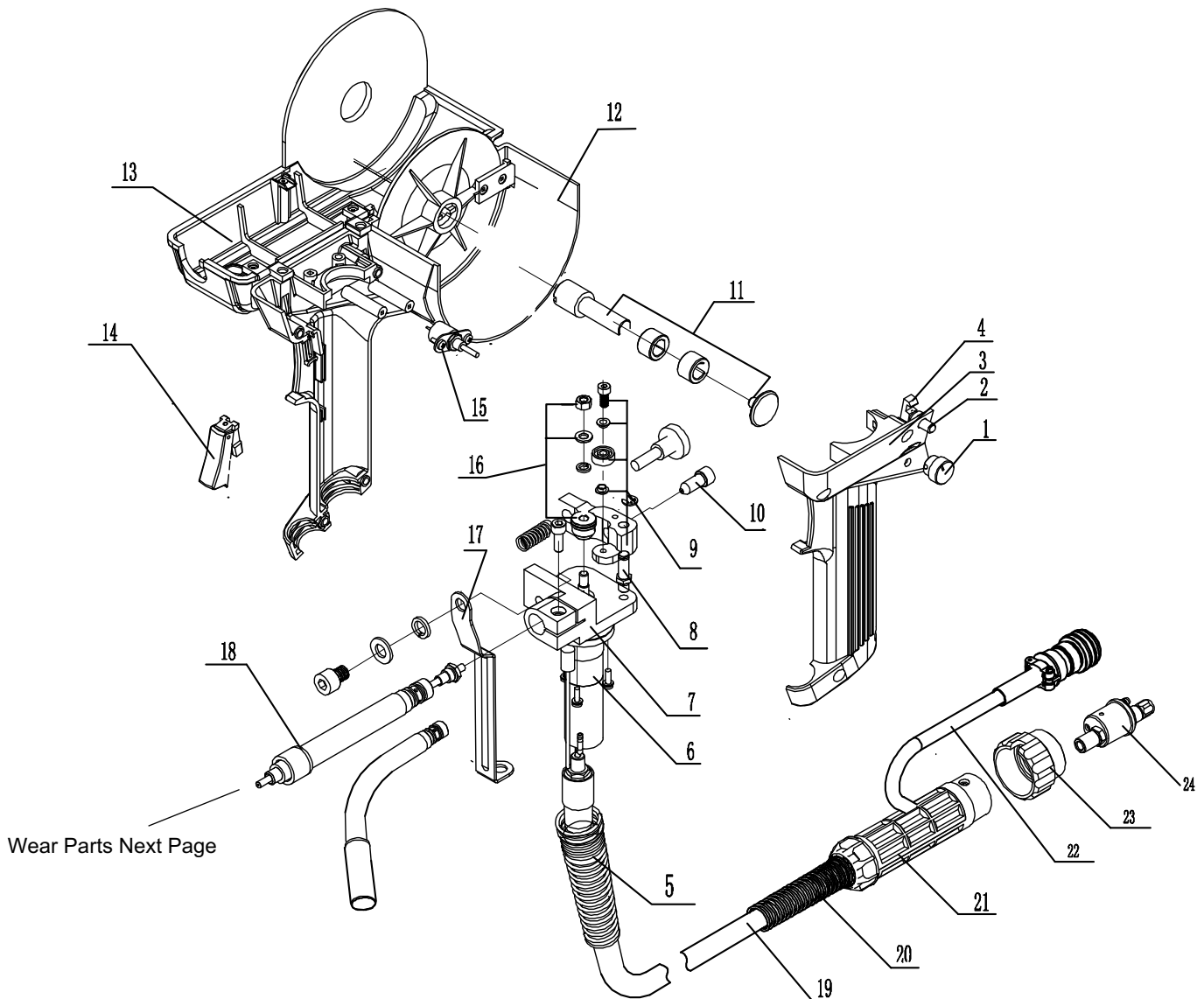

**Torch Model**

**Description**

**Part Number**

Spool Gun x 19ft

SPGRWA200

**Spare Parts**

Part Number	Description	Part Number	Description		
1	LMZ2017	Speed Adjusting Knob	15	LMZ2014	Potentiometer
2	LMH2114	Open/Close Button	16	LMZ2015	Push Roll
3	LMH2111	Left-Gun Case	17	LMK2001	Conducting Board
4	LMH2115	Hang Hook	18	EF1101	Conducting Tube
5	LMS2101	Spring Support	19	LML2140	Welding Cable
6	LMZ2001	Motor	20	ES1201	Spring Support (Back)
7	LMZ2011	Motor Plate	21	EH2201	Adaptor Support
8	LMZ2012	Suspension Screw	22	LMV2007	Adaptor Support Nut
9	LMZ2013	Drive Roll Assembly	23	EP2001	Adaptor
10	LMZ2016	Wire Nipple	24	LMV0004	4 Pin Plug
11	LMT2101	Spool Shaft			
12	LMH2112	Right-Gun Case			
13	LMH2113	Upper-Gun Case			
14	LMJ2101	Switch			

# SPG200II AMP SPOOL GUN



## TWC2 Contact Tips

Part Number	Description	QTY	EAN CODE
PRW14-30	Contact tip 0.8mm / 0.030"	QTY x5	0680474943920
PRW14-35	Contact tip 0.9mm / 0.035"	QTY x5	0680474943937
PRW14-40	Contact tip 1.0mm / 0.040"	QTY x5	0680474944033
PRW14-45	Contact tip 1.2mm / 0.045"	QTY x5	0680474944040



## TWC2 Contact Tips H/D

Part Number	Description	QTY	EAN CODE
PRW14H-30	Contact H/D tip 0.8mm / 0.030"	QTY x5	0680474944057
PRW14H-35	Contact H/D tip 0.9mm / 0.035"	QTY x5	0680474944064
PRW14H-40	Contact H/D tip 1.0mm / 0.040"	QTY x5	0680474944071
PRW14H-45	Contact H/D tip 1.2mm / 0.045"	QTY x5	0680474944088



## TWC2 Gas Diffuser

Part Number	Description	QTY	EAN CODE
PRW52	Gas Diffuser	QTY x 2	0680474943975



## TWC2 Gas Insulator

Part Number	Description	QTY	EAN CODE
PRW32	Insulator	QTY x 2	0680474943999



## TWC2 Torch Nozzle

Part Number	Description	QTY	EAN CODE
PRW22-50	Nozzle Adjustable 13mm / (33/67)	QTY x2	0680474943951
PRW22-62	Nozzle Adjustable 16mm / (5/8)	QTY x2	0680474943968



## TWC2 Liners

Part Number	Description	QTY	EAN CODE
PRW42-3035-15	Liner 15 ft 0.8 - 0.9mm / 0.030" - 0.035"	QTY x1	0680474944002
PRW42-4045-15	Liner 15ft 1.0 - 1.2mm / 0.040" - 0.0457"	QTY x1	0680474944101
PRW42N-3035-15	Liner 15ft 0.8- 0.9mm / 0.030" - 0.035" Alloy	QTYx 1	0680474944118





## 150A AIR COOLED TIG WELDING TORCH

Rating: 150A DC, 105A AC @35% duty cycle.



Wear Parts Identification Next Page

Torch Model	
Description	Part Number
SR17 Suregrip Tig Torch Package Euro Connection	13ft SRE17-13FTE

Spare Parts					
Part Number	Description	Part Number	Description		
1	WP17 Torch head	12	UERNCL-32 Neoprene Cover X 3.2mt		
	WP17F Torch head flexible		UERNCL-72 Neoprene Cover X 7.2mt		
2	57Y02 Back cap long	13	UERCO100-40 Sheath X 12.5ft Inc Leather Cover		
3	57Y03 Medium back cap		UERCO100-80 Sheath X 25ft Inc Leather Cover		
4	57Y04 Short back cap				
5	UER1MS Momentary Kit				
6	UERSWL4 Trigger Lead 12.5ft				
	UERSWL8 Trigger Lead 25ft				
7	UERSP1 Screw Pack				
8	UERH100 Small Ergo Tig Handle				
9	UERKJ100 Small Knuckle Joint				
10	UERLC200-08 Leather Cover X 0.8mt				
11	UERJK100 Jointing Repair Kit				

©All rights reserved. No part of this publication may be reproduced, stored in a retrieval system or transmitted by any means, electronic, mechanical, photocopying or otherwise without the prior permission of ©Uniarc® the copyright holder.





# SR17 EURO TIG TORCH

## Standard Front End Parts

<b>Part #</b> 18CG	<b>Description</b> Cup Gasket	<b>Part #</b> 10N30	<b>Description</b> Collet Body 1.0mm / 0.040"	<b>Part #</b> 10N49L	<b>Description</b> Long Alumina Nozzle Ø 8mm / (5/16) #5L
		<b>Part #</b> 10N31	<b>Description</b> Collet Body 1.6mm / (1/16)	<b>Part #</b> 53N48L	<b>Description</b> Long Alumina Nozzle Ø 10mm / (25/64) #6L
		<b>Part #</b> 10N32	<b>Description</b> Collet Body 2.4mm / (3/32)	<b>Part #</b> 53N47L	<b>Description</b> Long Alumina Nozzle Ø 11mm / (7/16) #7L
		<b>Part #</b> 10N28	<b>Description</b> Collet Body 3.2mm / (1/8)		

<b>Part #</b> 10N22	<b>Description</b> Collet 1.0mm / 0.040"	<b>Part #</b> 10N50	<b>Description</b> Alumina Nozzle Ø 6mm / (15/64) #4
<b>Part #</b> 10N23	<b>Description</b> Collet 1.6mm / (1/16)	<b>Part #</b> 10N49	<b>Description</b> Alumina Nozzle Ø 8mm / (5/16) #5
<b>Part #</b> 10N24	<b>Description</b> Collet 2.4mm / (3/32)	<b>Part #</b> 10N48	<b>Description</b> Alumina Nozzle Ø 10mm / (25/64) #6
<b>Part #</b> 10N25	<b>Description</b> Collet 3.2mm / (1/8)	<b>Part #</b> 10N47	<b>Description</b> Alumina Nozzle Ø 11mm / (7/16) #7
		<b>Part #</b> 10N46	<b>Description</b> Alumina Nozzle Ø 13mm / (33/64) #8
		<b>Part #</b> 10N45	<b>Description</b> Alumina Nozzle Ø 16mm / (5/8) #10
		<b>Part #</b> 10N44	<b>Description</b> Alumina Nozzle Ø 19mm / (3/4) #12

## Compact Gas Lens Front End Parts

<b>Part #</b> 54N01	<b>Description</b> Gas Lens Gasket	<b>Part #</b> 45V25	<b>Description</b> Gas Lens Body 1.6mm / (1/16)	<b>Part #</b> 54N14	<b>Description</b> Gas lens ceramic 8.0mm / (5/16)
		<b>Part #</b> 45V26	<b>Description</b> Gas Lens Body 2.4mm / (3/32)	<b>Part #</b> 54N15	<b>Description</b> Gas lens ceramic 7.0mm / (9/32)
		<b>Part #</b> 45V27	<b>Description</b> Gas Lens Body 3.2mm / (1/8)	<b>Part #</b> 54N17	<b>Description</b> Gas lens ceramic 5.0mm / (13/64)

### TR0004-16



**RED**  
ANSI/AWS A5.12-98  
ISO 6848 WT20

**2% Thoriated:** Best stability at medium currents, good arc starts, medium tendency to spit, medium erosion rate. Commonly used for steel and stainless steel applications

1/16 x 7" (1.6mm x 175mm)  
3/32 x 7" (2.4mm x 175mm)  
1/8 x 7" (3.2mm x 175mm)

<b>Part #</b>	<b>Description</b>
TR0004-10	1.0mm x 175mm / 0.040" x 6 57/64" thoriated tungsten electrode 2%
TR0004-16	1.6mm x 175mm / (1/16) x 6 57/64" thoriated tungsten electrode 2%
TR0004-24	2.4mm x 175mm / (3/32) x 6 57/64" thoriated tungsten electrode 2%
TR0004-32	3.2mm x 175mm / (1/8) x 6 57/64" thoriated tungsten electrode 2%

### TR0006-16



**WHITE**  
ANSI/AWS A5.12 M-98  
ISO 6848 WZ8

**.8% Zirconiated:** Balls well, handles higher current with less spitting, better arc starts and arc stability than pure tungsten. Commonly used for aluminium applications

1/16 x 7" (1.6mm x 175mm)  
3/32 x 7" (2.4mm x 175mm)  
1/8 x 7" (3.2mm x 175mm)

<b>Part #</b>	<b>Description</b>
TR0006-10	1.0mm x 175mm / 0.040" x 6 57/64" zirconiated tungsten electrode 1%
TR0006-16	1.6mm x 175mm / (1/16) x 6 57/64" zirconiated tungsten electrode 1%
TR0006-24	2.4mm x 175mm / (3/32) x 6 57/64" zirconiated tungsten electrode 1%
TR0006-32	3.2mm x 175mm / (1/8) x 6 57/64" zirconiated tungsten electrode 1%

# ARC(Stick) WELDING TROUBLE SHOOTING

The following chart addresses some of the common problems of MMA welding. In all cases of equipment malfunction, the manufacturer's recommendations should be strictly adhered to and followed.

<b>1: No arc</b>	
<i>Possible Reason</i>	<i>Suggested Remedy</i>
Incomplete welding circuit	Check earth lead is connected. Check all cable connections.
Wrong mode selected	Check the ARC selector switch is selected
No power supply	Check that the machine is switched on and has a power supply
<b>2: Porosity – small cavities or holes resulting from gas pockets in weld metal.</b>	
<i>Possible Reason</i>	<i>Suggested Remedy</i>
Arc length too long	Shorten the arc length
Work piece dirty, contaminated or moisture	Remove moisture and materials like paint, grease, oil, and dirt, including mill scale from base metal
Damp electrodes	Use only dry electrodes
<b>3: Excessive Spatter</b>	
<i>Possible Reason</i>	<i>Suggested Remedy</i>
Amperage too high	Decrease the amperage or choose a larger electrode
Arc length too long	Shorten the arc length
<b>3: Weld sits on top, lack of fusion</b>	
<i>Possible Reason</i>	<i>Suggested Remedy</i>
Insufficient heat input	Increase the amperage or choose a larger electrode
Work piece dirty, contaminated or moisture	Remove moisture and materials like paint, grease, oil, and dirt, including mill scale from base metal
Poor welding technique	Use the correct welding technique or seek assistance for the correct technique
<b>4: Lack of penetration</b>	
<i>Possible Reason</i>	<i>Suggested Remedy</i>
Insufficient heat input	Increase the amperage or choose a larger electrode
Poor welding technique	Use the correct welding technique or seek assistance for the correct technique
Poor joint preparation	Check the joint design and fit up, make sure the material is not too thick. Seek assistance for the correct joint design and fit up
<b>5: Excessive penetration - burn through</b>	
<i>Possible Reason</i>	<i>Suggested Remedy</i>
Excessive heat input	Reduce the amperage or use a smaller electrode
Incorrect travel speed	Try increasing the weld travel speed
<b>6: Uneven weld appearance</b>	
<i>Possible Reason</i>	<i>Suggested Remedy</i>
Unsteady hand, wavering hand	Use two hands where possible to steady up, practice your technique
<b>7: Distortion – movement of base metal during welding</b>	
<i>Possible Reason</i>	<i>Suggested Remedy</i>
Excessive heat input	Reduce the amperage or use a smaller electrode
Poor welding technique	Use the correct welding technique or seek assistance for the correct technique
Poor joint preparation and or joint design	Check the joint design and fit up, make sure the material is not too thick. Seek assistance for the correct joint design and fit up
<b>7: Electrode welds with different or unusual arc characteristic</b>	
<i>Possible Reason</i>	<i>Suggested Remedy</i>
Incorrect polarity	Change the polarity, check the electrode manufacturer for correct polarity

# MIG WELDING TROUBLE SHOOTING

The following chart addresses some of the common problems of MIG welding. In all cases of equipment malfunction, the manufacturer's recommendations should be strictly adhered to and followed.

<b>1: Excessive Spatter</b>	
<i>Possible Reason</i>	<i>Suggested Remedy</i>
Wire feed speed set too high	Select lower wire feed speed
Voltage too high	Select a lower voltage setting
Wrong polarity set	select the correct polarity for the wire being used - see machine setup guide
Stick out too long	Bring the torch closer to the work
Contaminated base metal	Remove materials like paint, grease, oil, and dirt, including mill scale from base metal
Contaminated mig wire	Use clean dry rust free wire. Do not lubricate the wire with oil, grease etc
Inadequate gas flow or too much gas flow	Check the gas is connected, check hoses, gas valve and torch are not restricted. Set the gas flow between 21-30cfh flow rate. Check hoses and fittings for holes, leaks etc Protect the welding zone from wind and drafts
<b>2: Porosity - small cavities or holes resulting from gas pockets in weld metal.</b>	
<i>Possible Reason</i>	<i>Suggested Remedy</i>
Wrong gas	Check that the correct gas is being used
Inadequate gas flow or too much gas flow	Check the gas is connected, check hoses, gas valve and torch are not restricted. Set the gas flow between 21-30cfh flow rate. Check hoses and fittings for holes, leaks etc. Protect the welding zone from wind and drafts
Moisture on the base metal	Remove all moisture from base metal before welding
Contaminated base metal	Remove materials like paint, grease, oil, and dirt, including mill scale from base metal
Contaminated mig wire	Use clean dry rust free wire. Do not lubricate the wire with oil, grease etc
Gas nozzle clogged with spatter, worn or out of shape	Clean or replace the gas nozzle
Missing or damaged gas diffuser	Replace the gas diffuser
Mig torch euro connect o-ring missing or damaged	check and replace the o-ring
<b>4: Wire stubbing during welding</b>	
<i>Possible Reason</i>	<i>Suggested Remedy</i>
Holding the torch too far away	Bring the torch closer to the work and maintain stick out of 5-10mm
Welding voltage set too low	Increase the voltage
Wire Speed set too high	Decrease the wire feed speed
<b>5: Lack of Fusion – failure of weld metal to fuse completely with base metal or a preceding weld bead.</b>	
<i>Possible Reason</i>	<i>Suggested Remedy</i>
Contaminated base metal	Remove materials like paint, grease, oil, and dirt, including mill scale from base metal
Not enough heat input	Select a higher voltage range and /or adjust the wire speed to suit
Improper welding technique	Keep the arc at the leading edge of the weld pool. Gun angle to work should be between 5 & 15° Direct the arc at the weld joint Adjust work angle or widen groove to access bottom during welding Momentarily hold arc on side walls if using weaving technique
<b>5: Excessive Penetration – weld metal melting through base metal</b>	
<i>Possible Reason</i>	<i>Suggested Remedy</i>
Too much heat	Select a lower voltage range and /or adjust the wire speed to suit Increase travel speed
<b>6: Lack of Penetration – shallow fusion between weld metal and base metal</b>	
Poor in incorrect joint preparation	Material too thick. Joint preparation and design needs to allow access to bottom of groove while maintaining proper welding wire extension and arc characteristics Keep the arc at the leading edge of the weld pool and maintain the gun angle at 5 & 15° keeping the stick out between 1/8-1/4in
Not enough heat input	Select a higher voltage range and /or adjust the wire speed to suit Reduce travel speed
Contaminated base metal	Remove materials like paint, grease, oil, and dirt, including mill scale from base metal.

## MIG WIRE FEED TROUBLE SHOOTING

The following chart addresses some of the common WIRE FEED problems during MIG welding. In all cases of equipment malfunction, the manufacturer's recommendations should be strictly adhered to and followed.

<b>1: No wire feed</b>	
<i>Possible Reason</i>	<i>Suggested Remedy</i>
Wrong mode selected	Check that the TIG/ARC/MIG selector switch set to MIG position
Wrong torch selector switch	Check that the STANDARD/SPOOLGUN selector switch is set to STANDARD position for MIG welding and SPOOLGUN when using the Spoolgun
<b>2: Inconsistent / interrupted wire feed</b>	
<i>Possible Reason</i>	<i>Suggested Remedy</i>
Adjusting wrong dial	Be sure to adjust the WIRE FEED and VOLTAGE dials for MIG welding. The AMPERAGE dial is for STICK and TIG welding mode
Wrong polarity selected	Select the correct polarity for the wire being used - see machine setup guide
Incorrect wire speed setting	Adjust the wire feed speed
Voltage setting incorrect	Adjust the voltage setting
Mig torch lead too long	Small diameter wires and soft wires like aluminium don't feed well through long torch leads - replace the torch with a lesser length torch
Mig torch lead kinked or too sharp angle being held	Remove the kink, reduce the angle or bend
Contact tip worn, wrong size, wrong type	Replace the tip with correct size and type
Liner worn or clogged (the most common causes of bad feeding)	Try to clear the liner by blowing out with compressed air as a temporary cure, it is recommended to replace the liner
Wrong size liner	Install the correct size liner
Blocked or worn inlet guide tube	Clear or replace the inlet guide tube
Wire misaligned in drive roller groove	Locate the wire into the groove of the drive roller
Incorrect drive roller size	Fit the correct size drive roller eg; .030in wire requires .030in drive roller
Wrong type of drive roller selected	Fit the correct type roller (e.g. knurled rollers needed for flux cored wires)
Worn drive rollers	Replace the drive rollers
Drive roller pressure too high	Can flatten the wire electrode causing it to lodge in the contact tip - reduce the drive roller pressure
Too much tension on wire spool hub	Reduce the spool hub brake tension
Wire crossed over on the spool or tangled	Remove the spool untangle the wire or replace the wire
Contaminated mig wire	Use clean dry rust free wire. Do not lubricate the wire with oil, grease etc

# TIG WELDING TROUBLE SHOOTING

The following chart addresses some of the common problems of DC TIG welding. In all cases of equipment malfunction, the manufacturer's recommendations should be strictly adhered to and followed.

<b>1: Tungsten burning away quickly</b>	
<b>Possible Reason</b>	<b>Suggested Remedy</b>
Incorrect Gas	Check that pure Argon is being used
No gas	Check the gas cylinder contains gas and is connected and the torch gas valve is open
Inadequate gas flow	Check the gas is connected, check hoses, gas valve and torch are not restricted. Set the gas flow between 21-30cfh flow rate
Back cap not fitted correctly	Make sure the torch back cap is fitted so that the o-ring is inside the torch body
Torch connected to DC +	Connect the torch to the DC- output terminal
Incorrect tungsten being used	Check and change the tungsten type if necessary
Tungsten being oxidised after weld is finished	Keep shielding gas flowing 10–15 seconds after arc stoppage. 1 second for each 10 amps of weld current.
<b>2: Contaminated tungsten</b>	
<b>Possible Reason</b>	<b>Suggested Remedy</b>
Touching tungsten into the weld pool	Keep tungsten from contacting weld puddle. Raise the torch so that the tungsten is off of the work piece 1/8-1/4in
Touching the filler wire to the tungsten	Keep the filler wire from touching the tungsten during welding, feed the filler wire into the leading edge of the weld pool in front of the tungsten
Tungsten melting into the weld pool	Check that correct type of tungsten is being used. Too much current for the tungsten size so reduce the amps or change to a larger tungsten
<b>3: Porosity - poor weld appearance and colour</b>	
<b>Possible Reason</b>	<b>Suggested Remedy</b>
Incorrect Gas	Check that pure Argon is being used
Inadequate gas flow / gas leaks	Check the gas is connected, check hoses, gas valve and torch are not restricted. Set the gas flow between 21-30cfh flow rate. Check hoses and fittings for holes, leaks etc.,
Moisture on the base metal	Remove all moisture from base metal before welding
Contaminated base metal	Remove materials like paint, grease, oil, and dirt, including mill scale from base metal
Contaminated filler wire	Remove all grease, oil, or moisture from filler metal.
Incorrect filler wire	Check the filler wire and change if necessary
<b>4: Yellowish residue / smoke on the alumina nozzle &amp; discoloured tungsten</b>	
<b>Possible Reason</b>	<b>Suggested Remedy</b>
Incorrect Gas	Use pure Argon gas
Inadequate gas flow	Set the gas flow between 21-30cfh flow rate
Alumina gas nozzle too small for size of tungsten being used	Increase the size of the alumina gas nozzle
<b>5: Unstable Arc during DC welding</b>	
<b>Possible Reason</b>	<b>Suggested Remedy</b>
Torch connected to DC +	Connect the torch to the DC- output terminal
Contaminated base metal	Remove materials like paint, grease, oil, and dirt, including mill scale from base metal.
Tungsten is contaminated	Remove 10mm of contaminated tungsten and re grind the tungsten
Arc length too long	Lower torch so that the tungsten is off of the work piece 2 - 5mm
<b>7: Arc wanders during DC welding</b>	
<b>Possible Reason</b>	<b>Suggested Remedy</b>
Poor gas flow	Check and set the gas flow between 21-30cfh flow rate
Incorrect arc length	Lower torch so that the tungsten is off of the work piece 1/8-1/4in
Tungsten incorrect or in poor condition	Check that correct type of tungsten is being used. Remove 1/2in from the weld end of the tungsten and re sharpen the tungsten
Poorly prepared tungsten	Grind marks should run lengthwise with tungsten, not circular. Use proper grinding method and wheel.
Contaminated base metal	Remove contaminating materials like paint, grease, oil, and dirt, including mill scale from base metal.
Contaminated filler wire	Remove all grease, oil, or moisture from filler metal.
Incorrect filler wire	Check the filler wire and change if necessary

## continued- TIG WELDING TROUBLE SHOOTING

<b>8: Arc difficult to start or will not start DC welding</b>	
<b>Possible Reason</b>	<b>Suggested Remedy</b>
Incorrect machine set up	Check machine set up is correct
No gas, incorrect gas flow	Check the gas is connected and cylinder valve open, check hoses, gas valve and torch are not restricted. Set the gas flow between 10 - 15 l/min flow rate
Tungsten is contaminated	Remove 10mm of contaminated tungsten and re grind the tungsten
Incorrect tungsten size and or tungsten being used	Check and change the size and or the tungsten if required
Loose connection	Check all connectors and tighten
Earth clamp not connected to work	Connect the earth clamp directly to the work piece wherever possible

### **ATTENTION! - CHECK FOR GAS LEAKS**

At initial set up and at regular intervals we recommend to check for gas leakage.

Recommended procedure is as follows:

1. Connect the regulator and gas hose assembly and tighten all connectors and clamps.
2. Slowly open the cylinder valve.
3. Set the flow rate on the regulator to approximately 21-30cfh.
4. Close the cylinder valve and pay attention to the needle indicator of the contents pressure gauge on the regulator, if the needle drops away towards zero there is a gas leak.  
Sometimes a gas leak can be slow and to identify it will require leaving the gas pressure in the regulator and line for an extended time period. In this situation it is recommended to open the cylinder valve, set the flow rate to 21-30cfh, close the cylinder valve and check after a minimum of 15 minutes.
5. If there is a gas loss then check all connectors and clamps for leakage by brushing or spraying with soapy water, bubbles will appear at the leakage point.
6. Tighten clamps or fittings to eliminate gas leakage.

**Important: We strongly recommend that you check for gas leakage prior to operation of your machine. We recommend that you close the cylinder valve when the machine is not in use. Jasic Technologies America, authorized representatives or agents of Jasic Technologies will not be liable or responsible for the loss of any gas.**

## WARRANTY

JASIC Technologies America Inc ('Us', 'We') warrants that the following products under RAZORWELD supplied by Us and purchased by you from an Authorised RAZORWELD Dealer throughout the U.S.A & Canada are free of Material and Faulty Workmanship defects except for those products listed under 'Warranty Exclusions'.

These terms and conditions supersede and exclude all former and other representations and arrangements relating to any warranties on these products.

## WARRANTY PERIOD

We offer the following 'Warranty Periods' from 'date of purchase':

An Extended Warranty Period of 6 months total shall apply only to Machinery where offered and warranty is registered online.

### RAZORWELD WELDING MACHINES

RAZORWELD DIY Series (Power Source Only)	3 Years	(Clause 3)
RAZORWELD JASIC Inverter MIG (Power Source Only)	3 Years	(Clause 3)
RAZORWELD JASIC Inverter MIG SWF (Power Source / Separate Wire Feeder Only)	3 Years	(Clause 3)
RAZORWELD JASIC Inverter TIG (Power Source Only)	3 Years	(Clause 3)
RAZORWELD Water Cooler	1 Year	(Clause 3)
RAZORWELD JASIC Series (Power Source Only)	3 Years	(Clause 3)
UNI-FLAME Regulators Argon/ Acetylene / Oxygen / LPG / Bobbin Flowmeter	1 Year	
UNI-FLAME Automatic Welding Helmet	2 Years	
RAZORWELD Automatic Welding Helmets	2 Years	
TORCHES -GMAW, GTAW, MMAW, PLASMA, EARTH LEADS, INTERCONNECTING CABLES, GAS HOSE	3 Months	(Clause 3)

**(Clause 1)** 3 year warranty on transformers, inductor and rectifier. 1 year warranty on PCB, and all other components.

**(Clause 2)** Gas Hose, Flashbacks are subject to and covered by the Manufacturer's Individual Warranty, Contact the manufacturer for details

**(Clause 3)** This only Covers Manufactures defaults on all accessories for the first three months after date of purchase.

• SELLER MAKES NO WARRANTIES EXPRESSED OR IMPLIED, INCLUDING BUT NOT BY WAY OF LIMITATION, ANY IMPLIED WARRANTY OF MERCHANTABILITY AND ANY IMPLIED WARRANTY OF FITNESS FOR A PARTICULAR PURPOSE, ON ANY ORDER EXCEPT THAT SELLER WARRANTS TITLE TO ALL GOODS FURNISHED BY SELLER AND EXCEPT THAT SELLER WARRANTS FOR A PERIOD OF ONE YEAR FROM THE DATE MARK LOCATED ON THE SELLER'S IDENTIFICATION TAG THAT ALL GOODS DESCRIBED ON SELLER'S ACKNOWLEDGMENT OF PURCHASER'S PURCHASE ORDER WILL BE MANUFACTURED IN ACCORDANCE WITH THE SPECIFICATIONS, IF ANY, SET FORTH IN SAID PURCHASE ORDER AND EXPRESSLY ACCEPTED IN SELLER'S ACKNOWLEDGMENT SUBJECT TO SELLER'S STANDARD MANUFACTURING VARIATIONS AND PRACTICES. IN THE CASE OF COMPONENTS OR ACCESSORIES FURNISHED BY SUPPLIERS TO SELLER, PURCHASER'S WARRANTY FROM SELLER SHALL BE LIMITED TO THE WARRANTY OF THE COMPONENT OR ACCESSORY SUPPLIER. THE FOREGOING WARRANTIES ARE THE SOLE AND EXCLUSIVE WARRANTIES APPLICABLE TO THE GOODS DELIVERED, AND ALL OTHER WARRANTIES, EXPRESS OR IMPLIED, INCLUDING WITHOUT LIMITATION ANY WARRANTY OF MERCHANTABILITY, ARE HEREBY EXPRESSLY DISCLAIMED AND NEGATED. WITHOUT LIMITING THE GENERALITY OF THE FOREGOING, PURCHASER ACKNOWLEDGES THAT SELLER'S PRODUCTS ARE NOT PACKAGED OR PROTECTED FOR LONG PERIODS OF STORAGE AND THUS MAY CORRODE OR RUST OVER TIME..

## **WARRANTY / RETURNS / EXCHANGES**

We understand that sometimes a product may need to be returned. If you have purchased from the RAZORWELD Authorised Dealer Network, to assist you in following the correct procedure enclosed is the returns policy.

Our Returns Policy includes the rights you have under the American consumer Law and other relevant laws.

. You are entitled to a replacement or refund for a major failure and for compensation for any other reasonably foreseeable loss or damage. You are also entitled to have the goods repaired or replaced if the goods fail to be of acceptable quality and the failure does not amount to a major failure.

- You shall inspect the Goods on delivery and shall within seven (7) days of delivery (time being of the essence) notify JASIC Technologies America Inc of any alleged defect, shortage in quantity, damage or failure to comply with the description or quote.
- You shall also afford JASIC Technologies America Inc the opportunity to inspect the Goods within a reasonable time following delivery if you believe the Goods are defective in any way.
- If you shall fail to comply with these provisions the Goods shall be presumed to be free from any defect or damage. For defective Goods, Which JASIC Technologies America Inc has agreed in writing that you are entitled to reject, JASIC Technologies America Inc 's liability is limited to, at the discretion of JASIC Technologies America Inc either replacing the Goods or repairing the Goods except where you have acquired Goods as a consumer within the meaning of the relevant State legislation and trade act policies and is therefore also entitled to, at the consumer's discretion either a refund of the purchase price of the Goods, or repair of the Goods, or replacement of the Goods.

Returns will only be accepted provided that:

- (a) You have complied with the provisions outlined above, and
- (b) where the Goods are unable to be repaired, the Goods are returned at your cost within thirty (30) days of the delivery date, and
- (c) JASIC Technologies America inc will not be liable for Goods which have not been stored or used in a proper manner, and
- (d) the Goods are returned in the condition in which they were delivered and with all packaging material, brochures and instruction material in as new condition as is reasonably possible in the circumstances.

- JASIC Technologies America Inc Accepts no responsibility for products lost, damaged or mislaid whilst in transit
- JASIC Technologies America Inc may (at their sole discretion) accept the return of Goods for credit but this may incur a handling fee of up to fifteen percent (15%) of the value of the returned Goods plus any freight costs.
- Where a failure does not amount to a major failure, JASIC Technologies America Inc is entitled to choose between providing you with a repair, replacement or other suitable remedy.

### **PURCHASER'S REMEDIES :**

WITH RESPECT TO ANY CLAIM ARISING OUT OF ANY ORDER, ANY GOODS DELIVERED PURSUANT TO ANY ORDER AND EXPRESSLY ACCEPTED IN SELLER'S ACKNOWLEDGMENT, OR SELLER'S PERFORMANCE IN CONNECTION WITH ANY ORDER, INCLUDING, WITHOUT LIMITATION, ANY CLAIM ARISING OUT OF ANY RECALL, DEFECT OR ALLEGED DEFECT IN ANY GOODS OR SERVICES FURNISHED BY SELLER, SHALL BE LIMITED EXCLUSIVELY TO THE RIGHT OF REPAIR OR REPLACEMENT OF SUCH GOODS OR SERVICES, AT SELLER'S OPTION. WITHOUT IN ANY WAY LIMITING THE GENERALITY OF THE FOREGOING, IN NO EVENT SHALL SELLER BE LIABLE FOR ANY CONSEQUENTIAL OR INCIDENTAL DAMAGES, INCLUDING, WITHOUT LIMITATION, ANY LOSS OF ANTICIPATED PROFITS INCURRED BY PURCHASER WITH RESPECT TO ANY GOODS OR SERVICES FURNISHED BY SELLER, OR ANY DAMAGES ARISING FROM INJURIES TO PERSONS AS A RESULT OF PURCHASER'S OR A THIRD PARTY'S NEGLIGENCE. SELLER'S WARRANTY DOES NOT COVER FAILURES RESULTING FROM THE IMPROPER INSTALLATION, MOUNTING DESIGN OR APPLICATION OR FROM CORROSION. THE PROVISIONS OF THIS PARAGRAPH ARE A MATERIAL TERM OF THIS TRANSACTION.

### **MAKING A CLAIM**

If you wish to make a claim under this Warranty, you should:

- Return the product to the point of purchase either in person or on a prepaid courier; or
  - Contact Us by Telephone on (+1) 253-859-6277, 253-859-6278 or e-mail [service@razorweld.com](mailto:service@razorweld.com)
- 
- When returned, the product must be accompanied with the original invoice including the purchase price and disclosing the purchase date
  - All costs of installation, cartage, freight, travelling expenses, hiring tools and insurance are paid by the Customer.
  - To the extent permitted by law, our total liability for loss or damage of every kind related to the product in any way whatsoever is limited to the amount paid to the retailer by you for the product or the value of the product.

No responsibility will be taken for products lost, damaged or mislaid whilst in transit.



## WARRANTY EXCLUSIONS

This Warranty covers Material and Faulty Workmanship defects only.

This Warranty does not cover damage caused by:

- Normal wear and tear due to usage
- Misuse or abusive use of the RAZORWELD instructions supplied with the product.
- Failure to clean or improper cleaning of the product
- Failure to maintain the equipment such as regular services etc
- Incorrect voltage or non-authorized electrical connections
- Improper installation
- Use of non-authorized/non-standard parts
- Abnormal product performance caused by any ancillary equipment interference or other external factors
- Failure or any breakage caused by overload, dropping or abusive treatment or use by the customer
- Repair, modifications or other work carried out on the product other than by an Authorized RAZORWELD Dealers

Unless it is a manufacturing fault, this Warranty does not cover the following parts:

### **MIG Welding Torches and Consumables to suit, such as:**

Gas Nozzles, Gas Diffusers, Contact Tip holder, Contact tip, Swan Necks, Trigger, Handle, Liners, Wire Guide, Drive Roller, Gas Nozzle Spring, Neck Spring, Connector Block, Insulator, Gas Nipple, Cap, Euro Block, Head Assembly, Gas Block, Trigger Spring, Spring Cable Support, Neck Insulator, Shroud Spring, Gun Plug Cover, Lock Nut, Snap On Head, Spring Cap, Ball, Motor 42 Volt, Pot 10K standard, Knob, Drive Roll Seat, Washer, Bow, Ball Bearing, Wire Conduit Nipple, Central Plug, Printed Circuit Board, Gun Plug House, Cable Support, Gas Connector, Handle To Suit PP36 with Knobs, & Electrodes, Arc Leads, Welding Cable, Electrode Holder, Earth Clamps

### **TIG Welding Torches and Consumables to suit, such as:**

Tungsten Electrodes, Collet, Collet Body, Alumina Nozzle, Torch Head, Torch Head water Cooled, Torch Head Flexible, Back Caps, Gas Lens, Torch Handle, Cup Gasket, Torch Body Gas Valve, O-ring, Arc Leads, Welding Cable, Electrode Holder, Earth Clamps.

### **PLASMA Cutting Torches and Consumables to suit, such as:**

All Cutting Tips, All Diffuser/Swirl Ring, All Electrode, Retaining Caps, Nozzle Springs, All Spacers, All Shield Caps, All Air and Power Cables, All Switches, All O-rings, All Springs, All Circle Guides and Cutting Kits, Torch Bodies, Air Filter Regulator, Arc Leads, Welding Cable, Electrode Holder, Earth Clamps

### **STRAIGHT LINE CUTTING MACHINES and Consumables to suit, such as:**

Hoses, Fittings, Track, Cutting Nozzles.

HIT-8SS Welding Carriage Consumables to suit, such as:

Input Cord, Inter-connecting Cord, Triggering Cable.

This Warranty does not cover products purchased:

- From a non-authorized Dealer (such as purchases from unauthorized retailers and purchases over the Internet from unauthorized local/international sellers or sites such as EBay)
- At an auction;
- From a private seller Unless it is a manufacturing fault, this Warranty does not apply to any products sold to Hire Companies.

These conditions may only be varied with the written approval of the Directors of JASIC Technologies America Inc

**REMEMBER TO RETAIN YOUR ORIGINAL INVOICE FOR PROOF OF PURCHASE.**







## Razorweld®

JASIC Technologies America Inc  
25503 74th Ave S Kent WA 98032 USA

Phone: +1 253-859-6277

+1 253-859-6278

FAX: +1 253-859-6286

EMAIL: [sales@jasictechamerica.com](mailto:sales@jasictechamerica.com)

[sales@razorweld.com](mailto:sales@razorweld.com)

Part of the JASIC group of companies

MADE IN CHINA